

Safety precautions

1. The device must be installed by a qualified person,
2. Disconnect all power before working on the device. Don't touch any terminal when the power is ON.
3. Verify correct terminal connection when wiring.
4. Don't dismantle or repair the device whether it operates normally, otherwise no responsibility is assumed by producer and seller.
5. Never use the device at the site which can be invaded by corrode gas, strong sunshine light and rain.
6. Clean the device with a dry cloth.
7. Fail to follow these instructions will result in serious injury or death.

Features

- Microcontroller based
- 24 operating modes (functions)
- LCD display operating modes, set delay and operating time
- Time ranges: 0-9999s, 0-9999min
- AC/DC 24-240V supply voltage
- 2 independent NO contacts, can be controlled by different operating modes.
- Backlight LCD display
- Easy setting by keys
- 2 module Din rail mounting

Technical data

Supply terminals	A1, A2
Pulse terminal	S
Supply voltage	AC/DC 24-240V
Rated frequency	50/60Hz
Time range	0-9999s, 0-9999min
Repetition accuracy	max. ±3s/24h 25°C
Data readout	Back-lighted LCD display
Data storage	10 year
Output contacts	1 C/O + 1 NO
Current rating	8A / AC1
Contacts capacity	AC-15: 2A
Insulation voltage	250V
Protection degree	IP20
Pollution degree	3
Electrical life	10 ⁵
Mechanical life	10 ⁶
Altitude	2000m
Ambient temperature	-5°C~+40°C
Storage temperature	-10°C~+50°C
Wire size	0.5mm ² ~1mm ²
Torque	0.5Nm
Mounting	TH-35 DIN-Rail

Appearance

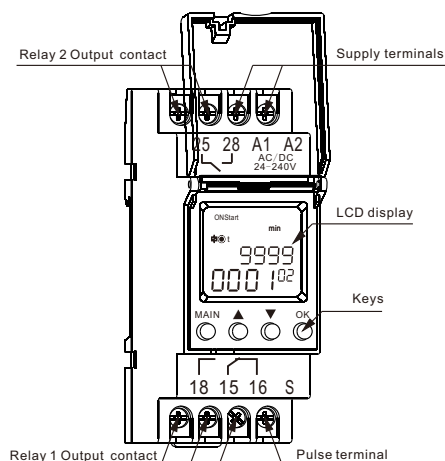

RD-TMS2

DIGITAL MULTIFUNCTION TIME RELAY

Please read complete instructions prior to installation and operation of the device.

Display and keys

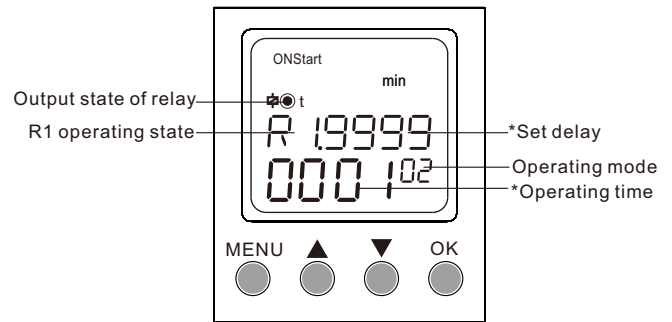

*: No display for operating mode 09,13,14.

Symbol legend

☉	— Output relay ON	min	— Set time: minute
☐	— Output relay OFF	sec	— Set time: second
R 1	— Output relay 1	T	— Time delay T
R 2	— Output relay 2	T 1	— Time delay T 1
SET	— Parameters setting	T 2	— Time delay T 2
ONStart	— Starting with ON	start	— Starting with S pulse
OFFStart	— Starting with OFF		
┌	— Time impulse release by rising edge		
└	— Time impulse release by falling edge		

Keys

MENU	○ Enter configuration menu ○ Exit configuration menu	OK	Confirm settings
▲	Select menu ○ Digit + ○ Display menu selection	▼	○ Select menu ○ Digit - ○ Display menu selection

Inquire the operating state of R1/R2

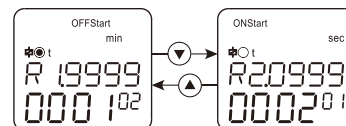

Note: the inquiry need to be carried out when operating

Wiring diagram

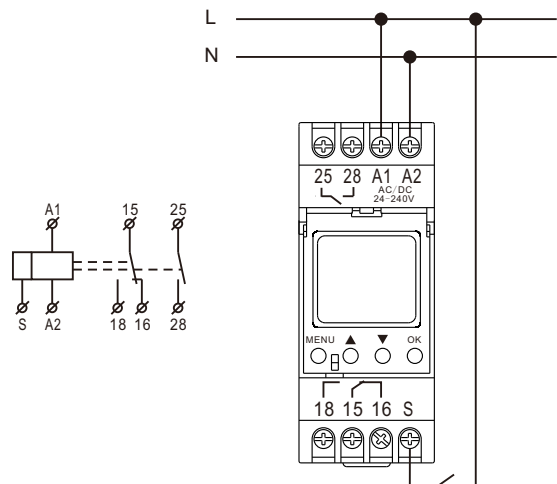

Main menu

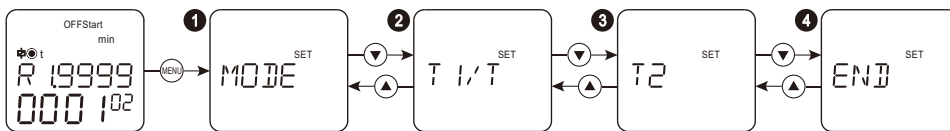

1	MODE	Operating mode adjustment
2	T1/T	T1/T time adjustment
3	T2	T2 time adjustment
4	END	End setting

- Press **MENU** key to enter configuration menu, symbol "SET" appears
- If no operation by keys for 2 minutes, device will return to main menu
- Use **▲▼** keys to choose options

● Operating modes setting

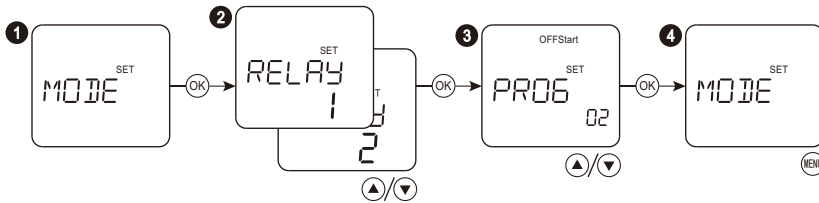

- 1 Choose **MODE** and press "OK" key.
- 2 Choose output relay with "▲▼" keys and press "OK" key.
- 3 Choose required modes with "▲▼" keys and press "OK" key. adjustment range is 01~24.
- 4 Returned to last sub-menu by pressing "MENU" key.

Long press ▲ 0.5s, increase the numerical value quickly
 Long press ▼ 0.5s, decrease the numerical value quickly

● T1/T delay setting

- 1 T1/T time setting menu, press "OK" key
- 2 Choose output relay with "▲▼" keys and press "OK" key.
- 3 Choose **SEC** with "▲▼" keys and press "OK" key. adjustment range is 0~9999seconds.
- 4 Choose the thousands of seconds with "▲▼" keys and press "OK" key. adjustment range is 0~9.
- 5 Choose the hundreds of seconds with "▲▼" keys and press "OK" key. adjustment range is 0~9.

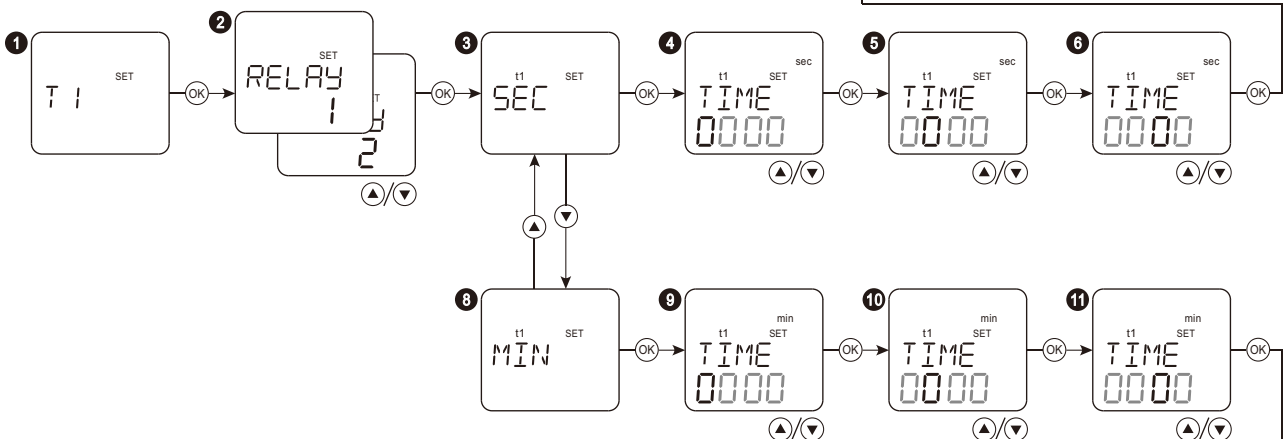

- 6 Choose the tens of seconds with "▲▼" keys and press "OK" key. adjustment range is 0~9.
- 7 Choose the units of seconds with "▲▼" keys and press "OK" key. adjustment range is 0~9.
- 8 Choose **MIN** with "▲▼" keys and press "OK" key. adjustment range is 0~9999minutes.
- 9 Choose the thousands of minutes with "▲▼" keys and press "OK" key. adjustment range is 0~9.
- 10 Choose the hundreds of minutes with "▲▼" keys and press "OK" key. adjustment range is 0~9.
- 11 Choose the tens of minutes with "▲▼" keys and press "OK" key. adjustment range is 0~9.
- 12 Choose the units of minutes with "▲▼" keys and press "OK" key. adjustment range is 0~9.
- 13 Returned to last sub-menu by pressing "MENU" key.

Long press ▲ 0.5s, increase the numerical value quickly
 Long press ▼ 0.5s, decrease the numerical value quickly

● T2 delay setting

- 1 T2 time setting menu, press "OK" key
- 2 Choose output relay with "▲▼" keys and press "OK" key.
- 3 Choose SEC with "▲▼" keys and press "OK" key. adjustment range is 0~9999seconds.
- 4 Choose the thousands of seconds with "▲▼" keys and press "OK" key. adjustment range is 0~9.
- 5 Choose the hundreds of seconds with "▲▼" keys and press "OK" key. adjustment range is 0~9.

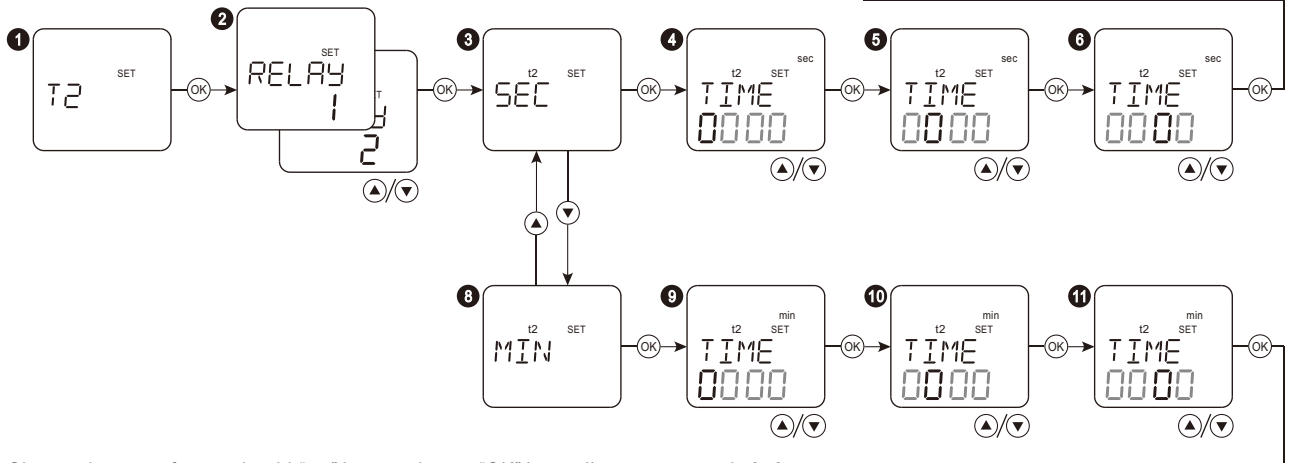









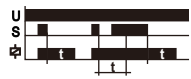



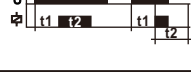

- 6 Choose the tens of seconds with "▲▼" keys and press "OK" key. adjustment range is 0~9.
- 7 Choose the units of seconds with "▲▼" keys and press "OK" key. adjustment range is 0~9.
- 8 Choose MIN with "▲▼" keys and press "OK" key. adjustment range is 0~9999minutes.
- 9 Choose the thousands of minutes with "▲▼" keys and press "OK" key. adjustment range is 0~9.
- 10 Choose the hundreds of minutes with "▲▼" keys and press "OK" key. adjustment range is 0~9.
- 11 Choose the tens of minutes with "▲▼" keys and press "OK" key. adjustment range is 0~9.
- 12 Choose the units of minutes with "▲▼" keys and press "OK" key. adjustment range is 0~9.
- 13 Returned to last sub-menu by pressing "MENU" key.

Long press ▲ 0.5s, increase the numerical value quickly
 Long press ▼ 0.5s, decrease the numerical value quickly

Diagramas de función

01		SWITCH ON DELAY - after the supply voltage has been applied the preset time t measure starts. After the time is over the relay switches on (pos. 15-18). The next switch on mode appears after power supply voltage reset.
02		SWITCH OFF DELAY - after the supply voltage has been applied, the relay switches on immediately (pos.15-18), and the preset time t is measured. After the preset time is measured, the relay is switched off (pos.15-16). The next switch on interval appears after power supply voltage reset.
03		FLASHER STARTING WITH OFF – (Starting from the switch off position). After the supply voltage has been applied, the preset time t is measured. After the time is over, the relay switches on (pos. 15-18). Again with the preset time t interval, the relay is switched off (pos.15-16) and switched on (pos. 15-18). The next switch on interval appears after power supply voltage reset
04		FLASHER STARTING WITH ON – (Starting from the switch on position). After the supply voltage has been applied, the relay is immediately switched on (pos. 15-18) and the preset time t is measured. After the time t is over, the relay switches off (pos.15-16). Again with the preset time t interval the relay is switched on (pos.15-18) and switched off (pos.15-16). The next switch on interval appears after power supply voltage reset.
05		IMPULSE GENERATOR DELAY 0,5 sec. - After the supply voltage has been applied the preset time t measure starts. After the time t is over the relay switches on (pos. 15-18) for 0,5 second, and switches off (pos. 11-12). The next switch on interval appears after power supply voltage reset.
06		TIME IMPULSE RELEASED BY RISING EDGE – after the impulse release has been applied to the power supply system (rising edge) it switches on the relay (pos. 15-18) and starts to measure the preset time. After the time t is over the relay is switched off (pos. 15-16). Impulse time duration is not important here.
07		TIME IMPULSE RELEASED BY FALLING EDGE – power supply system switches on the relay after impulse release fades (falling edge) (pos.15-18) and time measurement starts. After the time t is over the relay is switched off (pos. 15-16). The following impulse release fades during time measurement does not cause time measure from the beginning (non- retrigerrable).
08		SWITCH ON/OFF DELAY – after the impulse release has been applied to the power-supply system (rising edge), it lets the relay be switched off (pos.15-16) and at the same time starts the preset time t measurement. After the time is over the relay is switched on (pos.15-18). After the impulse release fade is detected (falling edge), again the system starts the preset time measurement. When it is over the relay is switched off (pos. 15-16). In case the impulse duration time is shorter than the preset time t, the relay is switched on only for the time t.
09		BISTABLE RELAY WITH TIME LIMIT – after the impulse release has been applied to the power supply system (rising edge), it switches on the relay (pos.15-18) and starts to measure the preset time t. The relay is switched off during the next impulse release (rising edge) or after time t is over in case there was no such impulse occurrence. Impulse time duration is not important for system operating.

10		TIME IMPULSE RELEASED BY RISING EDGE WITH SWITCH OFF DELAY (retriggerable) - after the impulse release has been applied to the power-supply system (rising edge) it switches on the relay (pos.15-18). After the impulse release fade is detected (rising edge), the system starts the preset time t measurement and when the time is over the relay is switched off (pos. 15-16). The following impulse release fade during time measurement causes time measure from the beginning (retriggerable).
11		TIME IMPULSE RELEASED BY RISING EDGE WITH SWITCH OFF DELAY (non-retriggerable) - after the impulse release has been applied to the power-supply system (rising edge) it switches on the relay (pos.15-18). After the impulse release fade is detected (falling modulated voltage), the system starts the preset time t measurement and when the time is over the relay is switched off (pos.15-16)
12		SWITCH ON DELAY RELEASED BY IMPULSE - after the impulse release has been applied to the power supply system (rising edge) it keeps the relay in a switched off position (pos. 15-16) and simultaneously starts the preset time t measurement. After the time t is over the relay is switched on (pos. 15-18). The relay is switched on as long as there is a power supply voltage on, the next release impulses do not affect operation of the relay.
13		PERMANENT SWITCH ON MODE - After the supply voltage has been applied the relay is switched on permanently. When choosing this mode t1 and t2 time adjustments do not matter.
14		PERMANENT SWITCH OFF MODE - After the supply voltage has been applied the relay is switched off permanently. When choosing this mode t1 and t2 time adjustments do not matter.
15		SWITCH ON DELAY - after the supply voltage has been applied the t1 time measure starts. After the time is over the relay switches on (pos. 15-18) for t2 time. The next switch on interval appears after power supply voltage reset.
16		SWITCH OFF DELAY - after the supply voltage has been applied, the output relay switches on immediately (pos.15-18), and the preset time t1 is measured. After the preset time is measured, the relay is switched off (pos. 15-16) for the preset t2 time and its another switch on mode. The next switch on interval appears after power supply voltage reset
17		FLASHER STARTING WITH OFF – (Starting from the switch off position). After the supply voltage has been applied, the preset time t1 is measured. After the time is over, the relay switches on (pos. 15-18) for the preset t2 time and again switches off (pos.15-16) for the preset t1 time. The next switch on interval appears after power supply voltage reset.
18		FLASHER STARTING WITH OFF – (Starting from the switch on position). After the supply voltage has been applied, the output relay switches on immediately (pos.15-18) for the preset time t1. After the time is over, the relay is switches off (pos.15-16) for the preset t2 time and its another switch on mode for t1 time. The next switch on interval appears after power supply voltage reset
19		SWITCH ON/OFF DELAY- (retriggerable) – after the impulse release has been applied to the power supply system (rising edge), it lets the relay be switched off (pos.15-16) and at the same time, starts the preset time t1 measurement. After the time is over the relay is switched on (po. 15-18). After the impulse release fade is detected (falling modulated voltage), the system starts preset t2 time measurement and after it is over the relay is switched off (po. 15-16). In case the impulse release duration is shorter than the preset time t1, the relay is not switched on. Applying the impulse release during the preset t2 time measurement does not cause switching off the relay but it starts time measurement after the impulse fade (falling modulated voltage).
20		SWITCH ON/OFF DELAY- (non-retriggerable) – after the impulse release has been applied to the power-supply system (rising edge), it lets the relay be switched off (pos.15-16), at the same time, starts the preset time t1 measurement. After the time is over the relay is switched on (pos. 15-18). After the impulse release fade is detected (falling modulated voltage), the system starts preset time t2 measurement and after it is over the relay is switched off (po. 15-16).The release input state can change during the time t2 measurement and does not affect functioning of the system In case the impulse release duration is shorter than the preset time t1, the relay is not switched on.
21		IMPULSE GENERATION WITH AN ALTERNATE TIME DURATION - after the impulse release has been applied to the power-supply system (growing value), it switches on the relay for the preset time t1, and switches it off. The next impulse release causes the relay switches on for t2 time. Another one switches on the relay for t1 time, etc. The impulse release time duration does not influence the relay switching on time.
22		SWITCH OFF DELAY RELEASED BY FALLING EDGE- after the impulse release has been applied to the power supply system, it switches on the relay (pos. 15-18). Impulse release fade causes the preset time t1 measurement, after it is over the relay is switched off (po. 15-16) for the preset time t2. During the t2 time the system is resistant to signals release. After the t2 time is over the relay is switched on again in the moment of applying impulse release (growing value)
23		TIME IMPULSE RELEASED BY IMPULSE WITH SPECIFIC TIME DURATION - after the impulse release has been applied and lasts continuously for the preset time t1, it switches on the relay (pos.15-18) for time t2. If the release impulse is shorter than the preset time t1, the relay is not switched on - during switching on the relay the releasing impulses are ignored.
24		IMPULSE RELEASED BY FALLING EDGE - after the impulse release has been applied to the power supply system (rising edge), it switches on the relay for the preset time t1, and after the time elapses it switches off the relay. The impulse release fade (falling edge) switches on the relay (pos. 15-18) for the preset time t2, and after the time elapses it switches it off. During switching on the relay the rising edge and the falling edge are ignored.