









12 A / 250 V AC

- Relays of general application • For plug-in sockets: on 35 mm rail mount acc. to EN 60715; on panel mounting; with terminals for soldering
- AC and DC coils, insulation class F: 155 °C
- WT (mechanical indicator + lockable front test button) - standard features of relays. Relays may be provided with the test buttons (no latching) and plugs - page 380
- Recognitions, certifications, directives: RoHS,     

Contact data

Number and type of contacts		2 CO
Contact material		AgNi , AgNi/Au flash gold plating
Rated / max. switching voltage	AC	250 V / 440 V
Min. switching voltage		10 V
Rated load (capacity)	AC1	12 A / 250 V AC
	AC15	3 A / 120 V 1,5 A / 240 V (B300)
	DC1	12 A / 24 V DC (see Fig. 3)
	DC13	0,22 A / 120 V 0,1 A / 250 V (R300)
Motor load	acc. to UL 508	1/2 HP 240 V AC, 4,9 FLA, single-phase motor 
	AC3 acc. to IEC 60947-4-1	0,37 kW 240 V AC, single-phase motor
Min. switching current		5 mA
Max. inrush current		24 A
Rated current		12 A
Max. breaking capacity	AC1	3 000 VA
Min. breaking capacity		0,3 W
Contact resistance		≤ 100 mΩ
Max. operating frequency		
• at rated load	AC1	1 200 cycles/hour
• no load		12 000 cycles/hour
Coil data		
Rated voltage	50/60 Hz AC	6, 12, 24 , 42, 48, 60, 80, 110, 115, 120, 127, 220, 230 , 240 V
	DC	5, 6, 12 , 24 , 48, 60, 80, 110, 125, 220 V
Must release voltage		AC: ≥ 0,2 U _n DC: ≥ 0,1 U _n
Operating range of supply voltage		see Tables 1, 2
Rated power consumption	AC	1,6 VA
	DC	0,9 W
Insulation according to EN 60664-1		
Insulation rated voltage		250 V AC
Rated surge voltage		4 000 V 1,2 / 50 μs
Overvoltage category		III
Insulation pollution degree		3
Dielectric strength		
• between coil and contacts		2 500 V AC type of insulation: basic
• contact clearance		1 500 V AC type of clearance: micro-disconnection
• pole - pole		2 500 V AC type of insulation: basic
Contact - coil distance		
• clearance		≥ 2,5 mm
• creepage		≥ 4 mm
General data		
Operating / release time (typical values)		AC: 10 ms / 8 ms DC: 13 ms / 3 ms
Electrical life		
• resistive AC1		> 10 ⁵ 12 A, 250 V AC
• cosφ		see Fig. 2
Mechanical life (cycles)		> 2 x 10 ⁷
Dimensions (L x W x H)		27,4 x 21 x 35,5 mm
Weight		35 g
Ambient temperature	• storage	-40...+85 °C
(non-condensation and/or icing)	• operating	AC: -40...+55 °C DC: -40...+70 °C
Cover protection category		IP 40 EN 60529
Environmental protection		RTI EN 61810-7
Shock resistance	(NO/NC)	10 g / 5 g
Vibration resistance		5 g 10...150 Hz

The data in bold type relate to the standard versions of the relays.  For single phase motors for 110-120 V AC do not use motors with higher FLA than given for 240 V AC.

Design

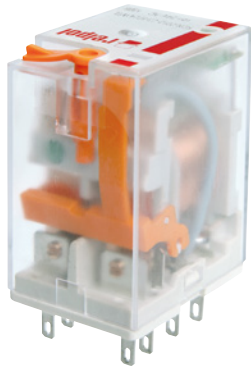

Improvement of the functionality of the mechanical indicator (W): it is mounted on an insulation base of the unit of the movable contacts; the changes provide the appropriate position in the window in the upper side of the housing irrespectively of the number of operations performed by the relay.

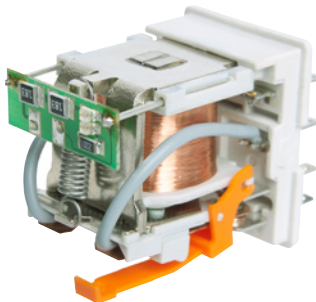

Application of electronics made in the SMD technology: additional features L (LED diode) and D (diode) are located on the printed circuit board; the change of the position of the LED diode and optimization of the quality and intensity of its light provide certainty that the relay is in operation status when the LED is on.



Improvement of the efficiency of the electromagnet: an innovational technology of connecting elements has been introduced, which guarantees more reliable operation of the relay.

Strengthening of the insulation in the area of the contact plate: polyamide PA66 has been applied; it has very good mechanical and electrical parameters and best thermal properties.

Dimensions - plug-in version (WT), with lockable front test button type T

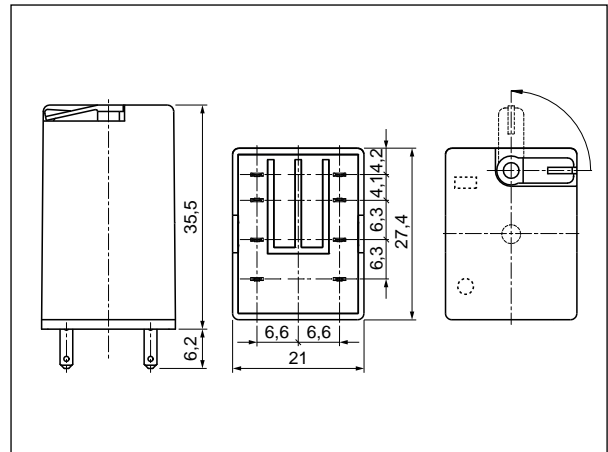

Dimensions - plug-in version, with test button (no latching) or with plug (no manual operation)

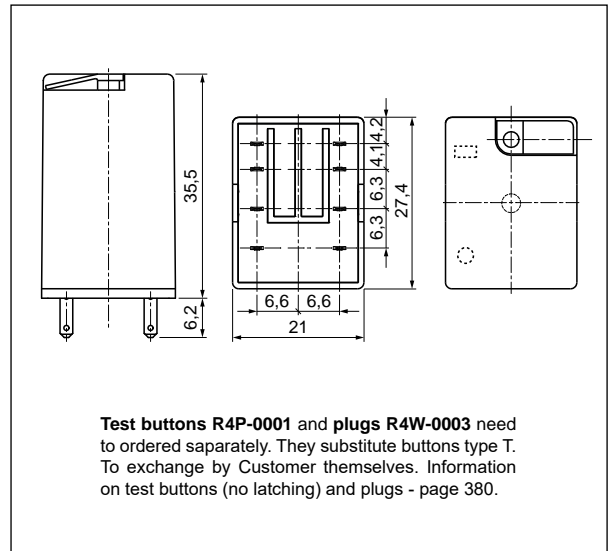

Connection diagram (pin side view)

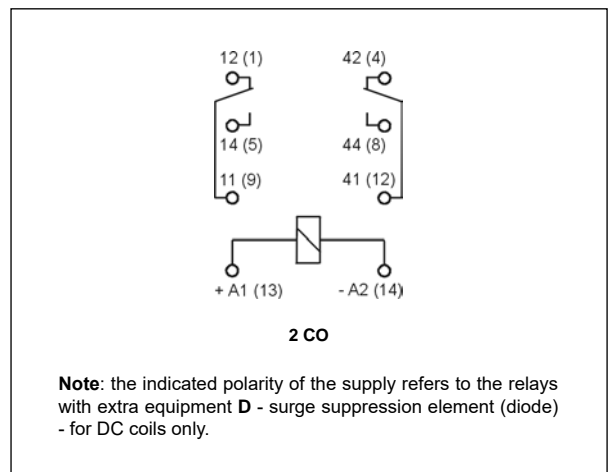

Electrical life at AC resistive load. Fig. 1
Switching frequency: 1 200 cycles/hour

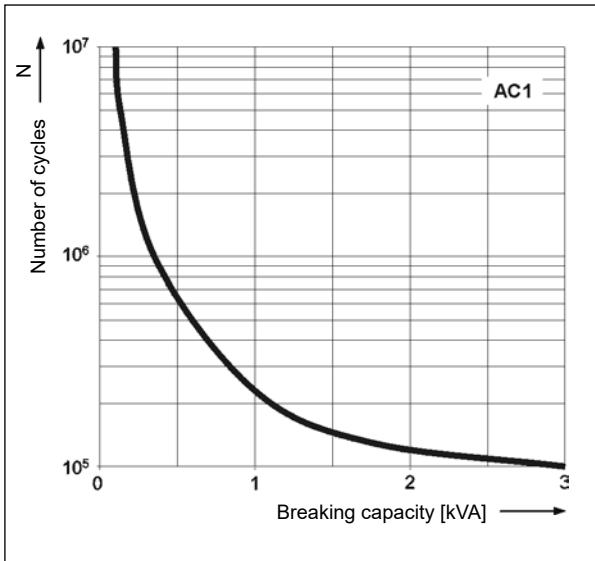

Electrical life reduction factor at AC inductive load Fig. 2

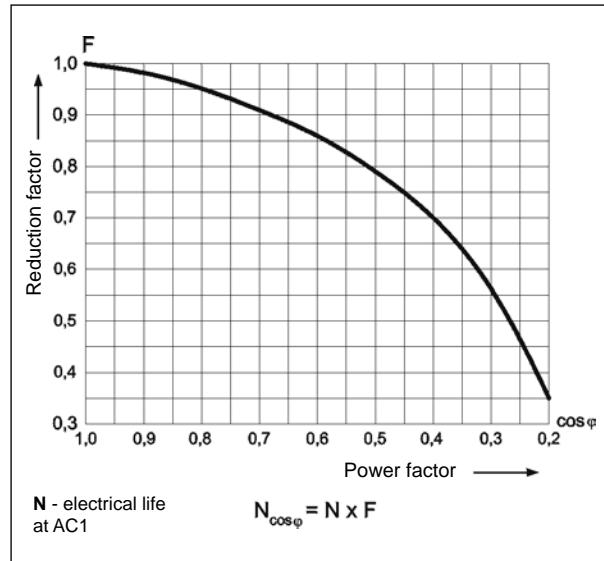

Contact material selection for different load types

- **AgNi** - for resistive or inductive loads,
- **AgNi/Au flash gold plating** - Au protects the contact surface during storage.

Max. DC resistive load breaking capacity Fig. 3

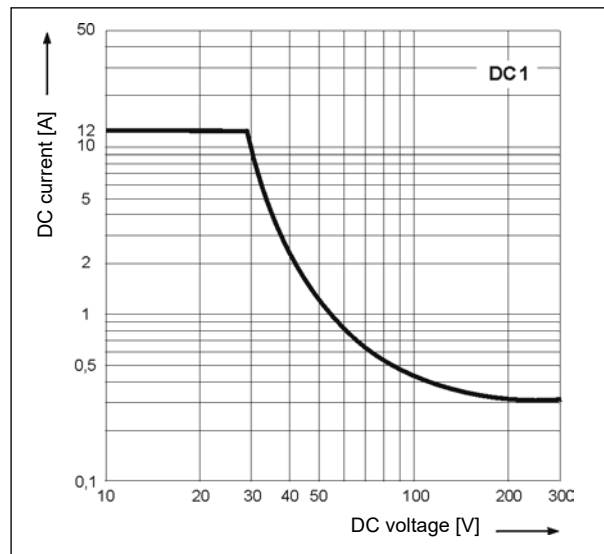

Mounting, sockets and accessories for relays

Relays **R2N** are designed for mounting in plug-in sockets. **With WT features as standard (W - mechanical indicator + T - lockable front test button)**. In these relays is **possibility self-exchange of button type T for test button R4P-0001 (no latching) or on plug R4W-0003 (no manual operation)**. The buttons **R4P-0001** and the plugs **R4W-0003** need to ordered separately.

Sockets for R2N	Accessories			Additional features
	Retainer / retractor clips	Spring wire clips	Description plates	
Screw terminals sockets, 35 mm rail mount (EN 60715) or on panel mounting (two M3 screws)				
GZT2	GZT4-0040	G4 1052	GZT4-0035	modules ②, strips ④
GZM2	GZT4-0040	G4 1052	GZT4-0035	modules ②, strips ④
Spring terminals sockets, 35 mm rail mount (EN 60715)				
GZMB2 ②	GZMB4-0040	G4 1052	TR	modules ②
Sockets for PCB				
SU4/2D	–	G4 1053	–	–
Solder terminals sockets				
SU4/2L	–	G4 1053	–	spring clamps ⑤
G4/2	–	G4 1053	–	–

② Sockets GZMB2: wire connection - see page 365. ③ Signalling / protecting modules type M... - see page 376. ④ Interconnection strips ZGGZ4 - see page 378. ⑤ Spring clamps G4 1040 for spring wire clips.

Coil data - DC voltage version

Table 1

Coil code	Rated voltage V DC	Coil resistance at 20 °C Ω	Acceptable resistance	Coil operating range V DC	
				min. (at 20 °C)	max. (at 70 °C)
1005	5	28	± 10%	4,0	5,5
1006	6	40	± 10%	4,8	6,6
1012	12	160	± 10%	9,6	13,2
1024	24	640	± 10%	19,2	26,4
1048	48	2 600	± 10%	38,4	52,8
1060	60	4 000	± 10%	48,0	66,0
1080	80	7 100	± 10%	64,0	88,0
1110	110	13 600	± 10%	88,0	121,0
1125	125	16 000	± 10%	100,0	137,5
1220	220	54 000	± 10%	176,0	242,0

The data in bold type relate to the standard versions of the relays.

Coil data - AC 50/60 Hz voltage version

Table 2

Coil code	Rated voltage V AC	Coil resistance at 20 °C Ω	Acceptable resistance	Coil operating range V AC	
				min. (at 20 °C)	max. (at 55 °C)
5006	6	9,8	± 10%	4,8	6,6
5012	12	39,5	± 10%	9,6	13,2
5024	24	158	± 10%	19,2	26,4
5042	42	470	± 10%	33,6	46,2
5048	48	640	± 10%	38,4	52,8
5060	60	930	± 10%	48,0	66,0
5080	80	1 720	± 10%	64,0	88,0
5110	110	3 450	± 10%	88,0	121,0
5115	115	3 610	± 10%	92,0	127,0
5120	120	3 770	± 10%	96,0	132,0
5127	127	4 000	± 10%	101,6	139,0
5220	220	15 400	± 10%	176,0	242,0
5230	230	16 100	± 10%	184,0	253,0
5240	240	16 800	± 10%	192,0	264,0

The data in bold type relate to the standard versions of the relays.

R2T, PIR2T

Relays for
railroad industry
- see
www.repol.com.pl

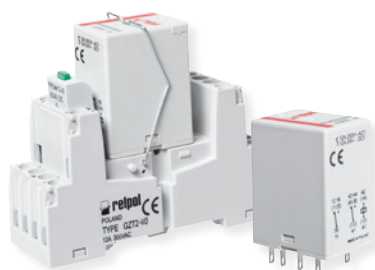

Ordering codes

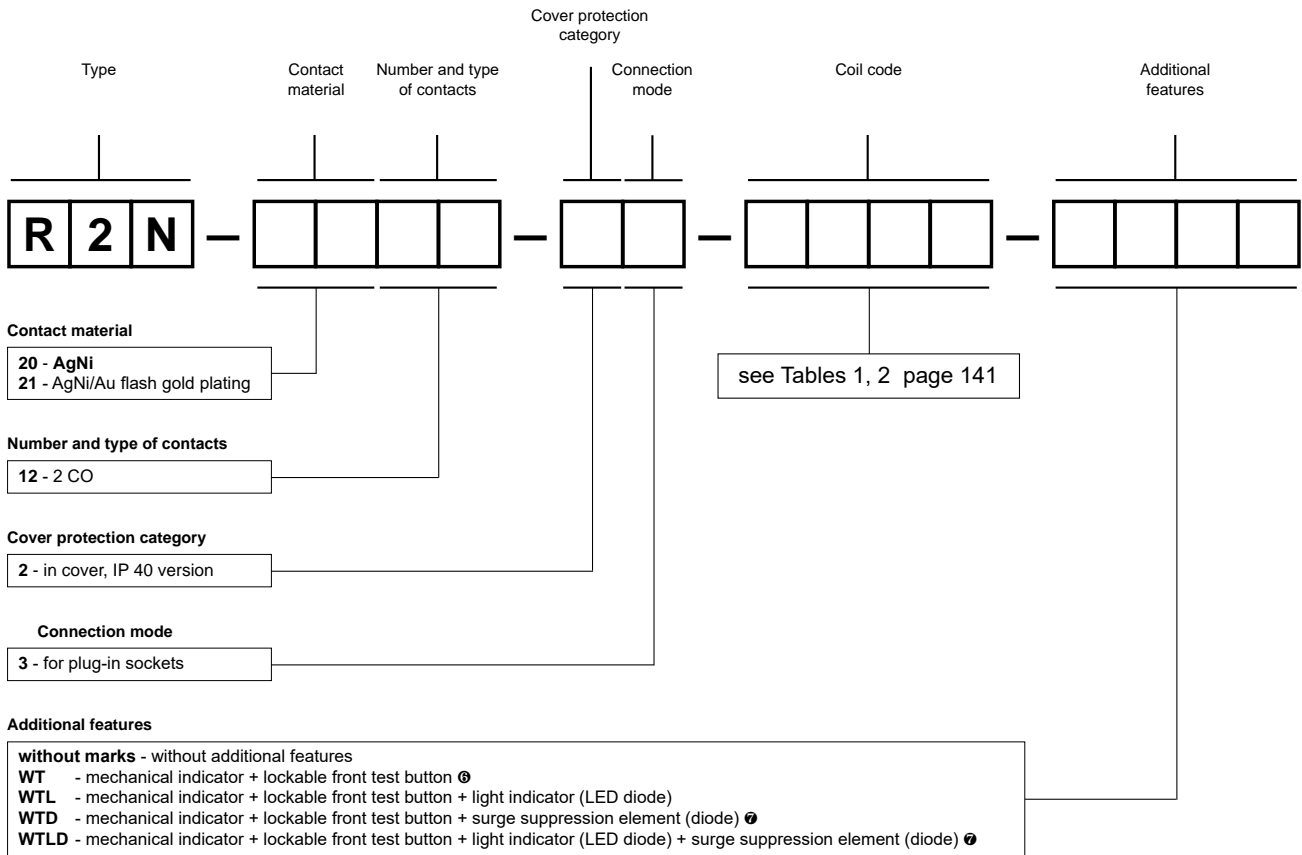

⑥ WT - standard features of relays

⑦ WTD, WTL D - available only in relays with DC coils

Test buttons (no latching) and plugs need to be ordered separately. They substitute buttons type T. To be exchanged by Customer themselves.

Information on test buttons (no latching) and plugs - page 380.

- Button R4P-0001-A - orange colour (AC coils)
- Button R4P-0001-D - green colour (DC coils)
- Plug R4W-0003-A - orange colour (AC coils)
- Plug R4W-0003-D - green colour (DC coils)

Note:

While the relay operates, the test button of the **T** type becomes heated. In order to push the test button manually, you should first turn the supply voltage off, and wait some time until the button becomes colder (or push the button immediately using a protective glove or an insulated tool). The button shall be pushed smoothly and quickly. The normally open contacts are closed with the button for the time during which the button is pushed. Releasing the button opens the normally open contacts. Normally open contacts may be closed with the blocking function of the button (it shall be turned by 90°). When the button is turned back, the normally open contacts are opened.

For relays with additional features **D** - surge suppression element (diode) (versions WTD and WTL D) - fixed supply polarity compulsory for the DC load of coils: +A1(13) / -A2(14). The polarity is indicated on the relay cover. For other versions of the relays with DC coils any polarity is possible.

Example of ordering codes:

R2N-2012-23-1024-WT relay **R2N**, for plug-in sockets, two changeover contacts, contact material AgNi, coil voltage 24 V DC, with mechanical indicator and lockable front test button, in cover IP 40