





Ø22/25 Emergency Switches (S2ER Series)

Type	Appearance	Model	Contact block		LED block										
			A contact	B contact	AC/DC voltage	AC voltage									
D30 (long head)	 S2ER-E1R□  	<b>S2ER-E1RA</b> (M)	1	—	—	—									
		<b>S2ER-E1R2A</b> (M)	2	—											
		<b>S2ER-E1R3A</b> (M)	3	—											
		<b>S2ER-E1RB</b> (M)	—	1											
		<b>S2ER-E1R2B</b> (M)	—	2											
		<b>S2ER-E1R3B</b> (M)	—	3											
		<b>S2ER-E1RAB</b> (M)	1	1											
		<b>S2ER-E1R2AB</b> (M)	2	1											
		<b>S2ER-E1RA2B</b> (M)	1	2											
※The M in the model name indicates modular type contact block. Models without M are singular contact block. ※The control unit, contact blocks, LED blocks are sold separately. (control unit: bold letters, contact block: regular letters)															
• Dimensions <span style="float: right;">(unit: mm)</span>															
															
<table border="1" style="margin-left: auto; margin-right: auto;"> <thead> <tr> <th></th> <th>A</th> <th>B</th> </tr> </thead> <tbody> <tr> <td>Singular type</td> <td>48.5</td> <td>27.0</td> </tr> <tr> <td>Modular type</td> <td>46.5</td> <td>25.0</td> </tr> </tbody> </table>								A	B	Singular type	48.5	27.0	Modular type	46.5	25.0
	A	B													
Singular type	48.5	27.0													
Modular type	46.5	25.0													
※For panel cut-out dimensions, please refer to page A-82.															

Type	Appearance	Model	Contact block		LED block										
			A contact	B contact	AC/DC voltage	AC voltage									
D30 (short head)	 S2ER-E2R□  	<b>S2ER-E2RA</b> (M)	1	—	—	—									
		<b>S2ER-E2R2A</b> (M)	2	—											
		<b>S2ER-E2R3A</b> (M)	3	—											
		<b>S2ER-E2RB</b> (M)	—	1											
		<b>S2ER-E2R2B</b> (M)	—	2											
		<b>S2ER-E2R3B</b> (M)	—	3											
		<b>S2ER-E2RAB</b> (M)	1	1											
		<b>S2ER-E2R2AB</b> (M)	2	1											
		<b>S2ER-E2RA2B</b> (M)	1	2											
※The M in the model name indicates modular type contact block. Models without M are singular contact block. ※The control unit, contact blocks, LED blocks are sold separately. (control unit: bold letters, contact block: regular letters)															
• Dimensions <span style="float: right;">(unit: mm)</span>															
															
<table border="1" style="margin-left: auto; margin-right: auto;"> <thead> <tr> <th></th> <th>A</th> <th>B</th> </tr> </thead> <tbody> <tr> <td>Singular type</td> <td>48.5</td> <td>27.0</td> </tr> <tr> <td>Modular type</td> <td>46.5</td> <td>25.0</td> </tr> </tbody> </table>								A	B	Singular type	48.5	27.0	Modular type	46.5	25.0
	A	B													
Singular type	48.5	27.0													
Modular type	46.5	25.0													
※For panel cut-out dimensions, please refer to page A0-78.															

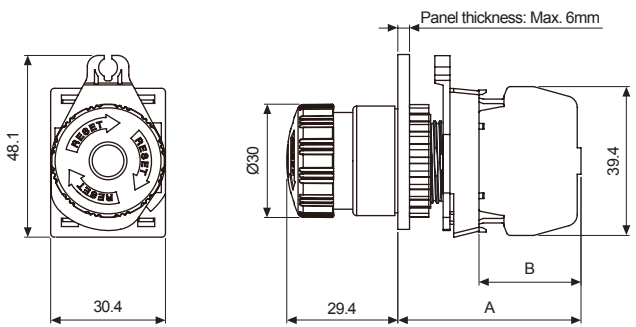

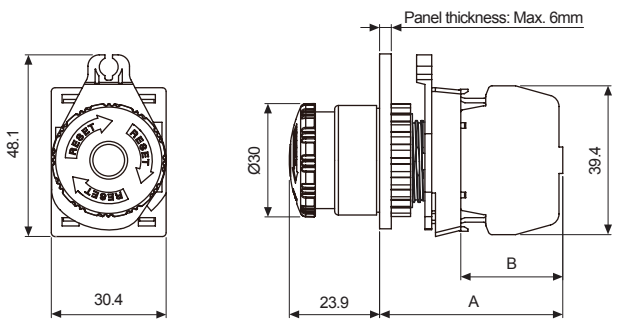
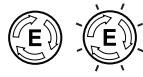
Control Switches

Ø16

Ø22/25

Ø30

□30

Push Button Switches

Round

Square

Rectangular

Selector Switches

Round

Square

Rectangular

Key Selector Switches

Round

Square

Rectangular

Double Push Button Switches

Mushroom-head Push Button Switches

Emergency Switches

Pilot Lights

Accessories

Buzzers

Type	Appearance	Model	Contact block		LED block	
			A contact	B contact	AC/DC voltage	AC voltage
D40 (short head)	 S2ER-E3R□	<b>S2ER-E3RA</b> (M)	1	—	—	—
		<b>S2ER-E3RA</b> (M)	2	—		
		<b>S2ER-E3R3A</b> (M)	3	—		
		<b>S2ER-E3RB</b> (M)	—	1		
		<b>S2ER-E3R2B</b> (M)	—	2		
		<b>S2ER-E3R3B</b> (M)	—	3		
		<b>S2ER-E3RAB</b> (M)	1	1		
		<b>S2ER-E3R2AB</b> (M)	2	1		
		<b>S2ER-E3RA2B</b> (M)	1	2		

※The M in the model name indicates modular type contact block. Models without M are singular contact block.  
 ※The control unit, contact blocks, LED blocks are sold separately.  
 (control unit: bold letters, contact block: regular letters)

• Dimensions (unit: mm)

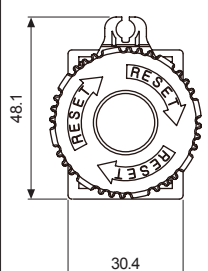
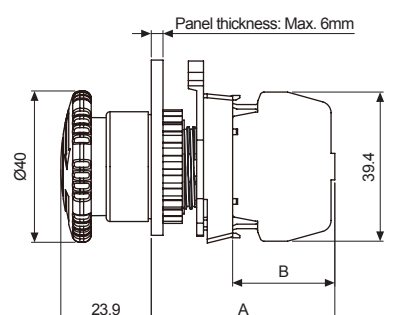
	A	B
Singular type	48.5	27.0
Modular type	46.5	25.0

※For panel cut-out dimensions, please refer to page A-82.

Type	Appearance	Model	Contact block		LED block	
			A contact	B contact	AC/DC voltage	AC voltage
D40 (short head/ illuminated)	 S2ER-E4R□	<b>S2ER-E4RAD</b> (M)	1	—	1	—
		<b>S2ER-E4R2AD</b> (M)	2	—	1	—
		<b>S2ER-E4R3A</b> (M)	3	—	—	—
		<b>S2ER-E4RBD</b> (M)	—	1	1	—
		<b>S2ER-E4R2BD</b> (M)	—	2	1	—
		<b>S2ER-E4R3B</b> (M)	—	3	—	—
		<b>S2ER-E4RABL</b> (M)	1	1	—	1
		<b>S2ER-E4R2AB</b> (M)	2	1	—	—
		<b>S2ER-E4RA2B</b> (M)	1	2	—	—

※The M in the model name indicates modular type contact block. Models without M are singular contact block.  
 ※The control unit, contact blocks, LED blocks are sold separately.  
 (control unit: bold letters, contact block, LED block: regular letters)

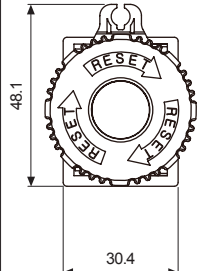
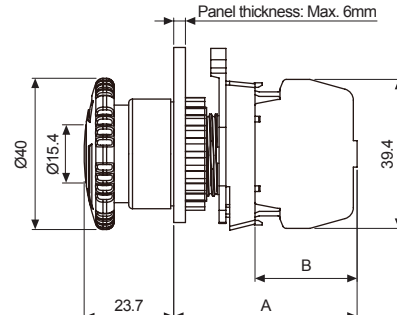

• Dimensions (unit: mm)

	A	B
Singular type	48.5	27.0
Modular type	46.5	25.0

※For panel cut-out dimensions, please refer to page A-82.





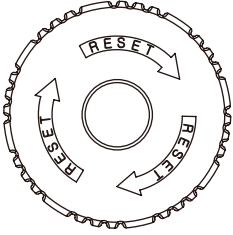
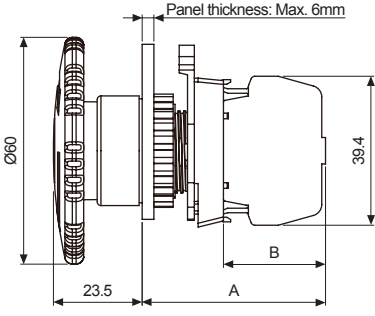



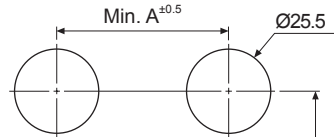
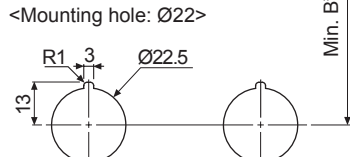

# Ø22/25 Emergency Switches

Type	Appearance	Model	Contact block		LED block										
			A contact	B contact	AC/DC voltage	AC voltage									
D60 (short head)	 S2ER-E5R□	<b>S2ER-E5RA</b> (M)	1	—	—	—									
		<b>S2ER-E5R2A</b> (M)	2	—											
		<b>S2ER-E5R3A</b> (M)	3	—											
		<b>S2ER-E5RB</b> (M)	—	1											
		<b>S2ER-E5R2B</b> (M)	—	2											
		<b>S2ER-E5R3B</b> (M)	—	3											
		<b>S2ER-E5RAB</b> (M)	1	1											
		<b>S2ER-E5R2AB</b> (M)	2	1											
		<b>S2ER-E5R2B</b> (M)	1	2											
※ The M in the model name indicates modular type contact block. Models without M are singular contact block. ※ The control unit, contact blocks, LED blocks are sold separately. (control unit: bold letters, contact block: regular letters)															
• Dimensions <span style="float: right;">(unit: mm)</span>															
					<table border="1"> <thead> <tr> <th></th> <th>A</th> <th>B</th> </tr> </thead> <tbody> <tr> <td>Singular type</td> <td>48.5</td> <td>27.0</td> </tr> <tr> <td>Modular type</td> <td>46.5</td> <td>25.0</td> </tr> </tbody> </table>			A	B	Singular type	48.5	27.0	Modular type	46.5	25.0
	A	B													
Singular type	48.5	27.0													
Modular type	46.5	25.0													
※ For panel cut-out dimensions, please refer to page A-82.															

# Ø22/25 Panel Cut-out Dimensions

## Ø22/25 Panel Cut-out Dimensions

(unit: mm)

Type		A	B	Panel Cut-out Dimensions
Round/Square Push Button Switches (S2PR/S2PRS Series)		 33	55	<p>&lt;Mounting hole: Ø25&gt;</p>  <p>&lt;Mounting hole: Ø22&gt;</p> 
Round Selector Switches (S2SR/S2SRN Series)	Short lever	 33	55	
	Long lever	 55	55	
Round Key Selector Switches (S2KR Series)		 33	55	
Double Push Button Switches (S2TR Series)		 33	60	
Mushroom-head Push Button Switches (S2BR Series)		 33	55	
Emergency Switches (S2ER Series)	D30	 33	55	
	D40	 55	55	
	D60	 80	80	
Pilot Lights (L2RR Series)		 33	55	