

LW26-10



LW26-20



LW26-25



LW26-32



LW26-63



◆ 产品简介 Introduction

LW26系列万能转换开关主要适用于交流50Hz、额定工作电压440V及以下、直流电压240V及以下，额定电流至160A的电气线路中，供手动不频繁接通或分断电路，作为控制或转换之用，也可直接控制三相异步电动机和作为主令控制及电路测量之用。产品用途广泛，可作为电路控制开关、测试设备开关、电动机控制开关和主令控制开关，及电焊机用转换开关等。

产品符合标准GB 14048.3, GB 14048.5及IEC 60947-3、IEC 60947-5-1。

LW26系列开关规格齐全，有10A、20A、25A、32A、63A、125A和160A等电流等级。

LW26系列开关具有体积小、功能多、结构紧凑、选材讲究、绝缘良好、转换操作灵活、安全可靠以及外观造型新颖等特点，其中LW26-10、LW26-20、LW26-25、LW26-32F四种开关还具有护指功能。

LW26系列开关适用性广，是一种新型理想的更新替代产品，可替代国内现有的LW2、LW5、LW6、LW8、LW12、LW15、HZ5、HZ10、HZ12等各类开关以及进口设备上的转换开关。

LW26系列开关派生产品有挂锁型开关和暗锁型开关（63A及以下），可用作重要设备的电源切断开关，防止误操作以及控制非授权人员的操作。

LW26系列开关中的20A至63A规格开关还可配备防护型外壳（IP65）。

The LW26 series rotary switch mainly applies to 440V and below, AC 50Hz or 240V and below DC circuits. For breaking and closing, change-over of circuits under unfrequently manual operation. And the typical application are: control switch of 3 phase motors, control switch of switch gear, control switch of instruments, and change-over switch of machinery and welding machine.

The series comply with the GB 14048.3, GB 14048.5 and IEC 60947-3, IEC 60947-5-1.

The LW26 series have 7 current ratings: 10A, 20A, 25A, 32A, 63A, 125A and 160A.

The LW26 series rotary switch were designed for multiple functions, wide variety of applications.

The LW26-10, LW26-20, LW26-25, and LW26-32F have finger protection terminals.

LW26 series rotary switch are an excellent substitute for LW2, LW5, LW6, LW8, LW12, LW15, HZ5, HZ10, and HZ12.

The LW26 series rotary switch has two derivatives, LW26GS Pad-lock and LW26S lock.

Both of them are applicable in circuits when an physical control is required.

We can equip protective box for 20A,25A,32A and 63A.

正常工作条件 Working conditions

- (1) 周围空气温度不超过 +40℃，且其 24 h 内的平均温度不超过 +35℃；
Ambient temperature Do Not exceed 40℃, and the average temperature, measured over a period of 24 hours, Do Not exceed 35℃.
- (2) 周围空气温度的下限不超过为 -25℃；
Ambient temperature should not be below -25℃.
- (3) 安装地点的海拔不超过2000 m；
Should Not be installed over 2000m above sea level.
- (4) 最高温度为 +40℃时，空气的相对湿度不超过50%，在较低的温度下可以允许有较高的相对湿度，例如20℃时达90%。对由于温度变化偶尔产生的凝露应采取特殊的措施。
The humidity should not exceed 50% when the ambient temperature is 40℃ and higher humidity is allowed for lower temperature.

安装条件 Installation conditions

- (1) 开关安装在污染等级3的环境条件；
A clean environment is required.
- (2) 根据本厂提供的说明书进行安装。
Please follow our manual.

LW26X-10



LW26-32F



LW26c-20



LW26-125



LW26-160



◆ 产品型号及其含义 Designation

主令控制用转换开关的型号及其含义

Use as control switches

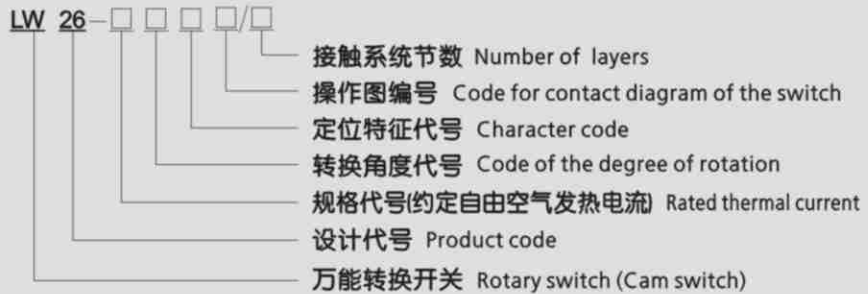

注：转换角度代号为30°(3)；45°(4)；60°(6)；90°(9)；30°自复60°定位(36)；30°自复90°定位(39)。

Re: Character code represent the rotating type, for instance, we have limited movement, spring return and limited movement with spring return.

直接控制电动机用转换开关的型号及其含义

Use as motor switch

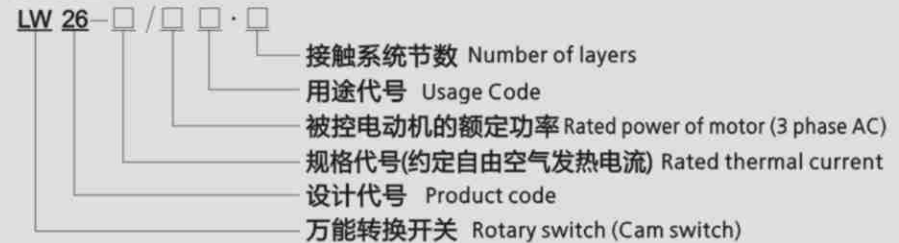

注1：用途代号：Q—直接起动 N—可逆转换 S—双速电动机变速 SN—双速电动机变速、可逆M16—三速电动机变速。

注2：直接控制电动机用转换开关一般采用60°转换或90°转换，代号SN时采用45°转换。

Re1:usage code (1)Q for start and run (2)N for start and reversing (3)S start and run at 2 speed (4)SN for start and reversing of 2 speed motor (5)M16 for start and reversing of 3 speed motor

Re2: switches in this category normally rotated at 60° or 90° . And the SN normally rotated at 45° .

主电路用转换开关的型号及其含义

Use as control switch for a main circuit

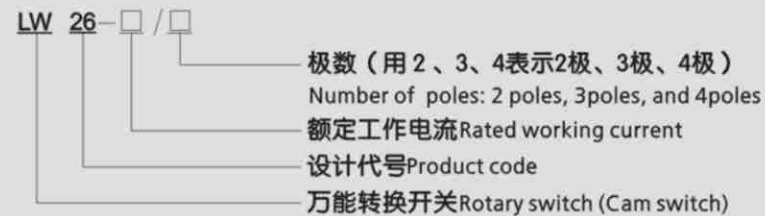

注：主电路用转换开关一般采用60°转换或90°转换。

Re: switches in this category normally rotated at 60° or 90° .

◆ 分类 Classification

1 按用途分 Classified by utilization

- (1) 主电路转换用转换开关; Change-over switch;
- (2) 直接控制电动机用转换开关; Motor switch;
- (3) 主令控制及测量用转换开关。Control switch.

2 按操作方式分 Classified by operation

- (1) 定位型; Limited movement;
- (2) 自复型; Spring return;
- (3) 定位自复型。Limited movement with spring return.

3 按接触系统分 Classified by contact system

- (1) 定位型转换开关有1~12节(63A及以上的开关仅有8节);
Switches with limited movement could have 12 layers in maximum (for 32A and below), and for 63A and above could have 8 layers in maximum;
- (2) 自复型转换开关有1~3节;
Switches with spring return could have 3 layers in maximum;
- (3) 直接控制电动机用转换开关主要有1~6节。
Motor switches could have 6 layers in maximum.

4 按操作方式与操动器位置组合如下表所示

Diagram for the operation and position of handle

操作方式 Operation angle	特征 代号 Character code	操 动 器 位 置 Position of handle			
		30° 转换 30° Rotation	45° 转换 45° Rotation	60° 转换 60° Rotation	90° 转换 90° Rotation
自复型 Spring return	A	0°-30°	0°-45°		
	B	30°-0°-30°	45°-0°-45°		
定位型 Limited movement	C	0° 30°	0° 45°	0° 60°	
	D	30° 0° 30°	45° 0° 45°	60° 0° 60°	
	E	30° 0° 30° 60°	45° 0° 45° 90°	90° 30° 30° 90°	
	F	60° 30° 0° 30° 60°	90° 45° 0° 45° 90°	90° 30° 30° 90° 150°	
	G	60° 30° 0° 30° 60° 90°	90° 45° 0° 45° 90° 135°	150° 90° 30° 30° 90° 150°	
	H	90° 60° 30° 0° 30° 60° 90°	135° 90° 45° 0° 45° 90° 135°		
	I	90° 60° 30° 0° 30° 60° 90° 120°	135° 90° 45° 0° 45° 90° 135° 180°		
	J	120° 90° 60° 30° 0° 30° 60° 90° 120°			
	K	120° 90° 60° 30° 0° 30° 60° 90° 120° 150°			
	L	150° 120° 90° 60° 30° 0° 30° 60° 90° 120° 150°			
	M	150° 120° 90° 60° 30° 0° 30° 60° 90° 120° 150° 180°			
	N	30° 30°	45° 45°	30° 30°	45° 45°
	P				90° 0° 90°
	T				0° 90°
V				90° 0°	
定位自复型 Limited movement with spring return	Z	30°-0° 60°	90° 0°-45°	60°-0° -60°	
		60°-30°-0°-30°-60°	135°-90° 0°-45°	90°-60° 0° 60°-90°	
		120°-90° 0°-30°	45°-0°-45°	120°-60° 0° 60°-120°	
	150°-60°-30°-0°-30°-60°-150°				

◆ 面板与手柄 Escutcheon plate and Handle

面板规格 Escutcheon plate

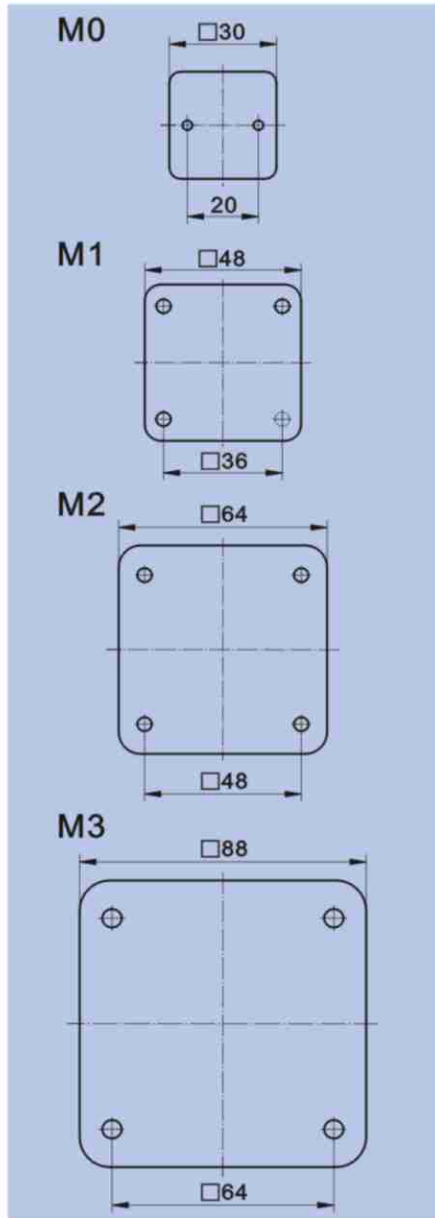

手柄类型 Type of handle

类型 Type of handle	颜色 Color	面板规格 Escutcheon plate				类型 Type of handle	颜色 Color	面板规格 Escutcheon plate			
		M0	M1	M2	M3			M0	M1	M2	M3
R 型 	黑 Red 白 灰 Gray	●	●	●		I 型 	黑 Red 白 灰 黄 Yellow	●	●	●	●
R2 型 	黑 Red 白 灰 Gray	●	●			B 型 	黑 Red 白 灰 Gray	●	●		
F 型 	黑 Red 白 灰 Gray	●	●	●		L 型 	黑 Red 白 灰 Gray				●
H 型 	黑 Red 白 灰 Gray				●	O 型 	黑 Red 白 灰 Gray				●
P 型 	黑 Red 白 灰 Gray				●	K 型 	黑 Red 白 灰 Gray				●

注：●为标准颜色，●为可选颜色下同。
Re: ● Standard, ● Optional.

型号规格 Description	面板规格 Escutcheon plate						手柄类型 Type of handle								转换角度 Rotating angle				最大节数 Maximum Number of layers				
	M0	M1	M1B	M2	M2B	M3	R	R2	F	I	B	H	L	O	P	K	30°	45°	60°	90°	12	10	8
LW26-10	●								●	●							●	●	●	●			●
LW26X-10	●								●	●							●	●	●	●			●
LW26-20		●	●	●	●		●	●	●	●	●	●	●	●	●	●	●	●	●	●			●
LW26c-20				●	●	●	●	●	●	●	●	●	●	●	●	●	●	●	●	●			●
LW26-25		●	●	●	●		●	●	●	●	●	●	●	●	●	●	●	●	●	●			●
LW26-32				●	●	●	●	●	●	●	●	●	●	●	●	●	●	●	●	●			●
LW26-32F				●	●	●	●	●	●	●	●	●	●	●	●	●	●	●	●	●			●
LW26-63				●	●	●	●	●	●	●	●	●	●	●	●	●	●	●	●	●			●
LW26-125						●		●							●	●	●	●	●			●	
LW26-160						●		●							●	●	●	●	●			●	

注：M1B、M2B面板需用自攻螺钉进行安装。
Re: M1B、M2B Platet should be installed by self tapping screw.

◆ 技术参数 Technical parameters

型号规格 Description		LW26-10	LW26-20	LW26-25	LW26-32	LW26-63	LW26-125	LW26-160
额定绝缘电压 Rated insulation voltage U_i	V	660	660	660	660	660	660	660
约定发热电流 Rated thermal current I_{th}	A	10	20	25	32	63	125	160
额定工作电压 Rated working voltage U_e	V	240 440	24 110 240 440	24 110 240 440	240 440	240 440	240 440	240 440
额定工作电流 Rated working current I_e								
AC-21A AC-22A	A	10 10	20 20	25 25	32 32	63 63	100 100	150 150
AC-23A	A	7.5 7.5	15 15	22 22	30 30	57 57	90 90	135 135
AC-2	A	7.5 7.5	15 15	22 22	30 30	57 57	90 90	135 135
AC-3	A	5.5 5.5	11 11	15 15	22 22	36 36	75 75	95 95
AC-4	A	1.75 1.75	3.5 3.5	6.5 6.5	11 11	15 15	30 30	55 55
AC-15	A	2.5 1.5	5 4	8 5	14 6			
DC-13	A		12 0.4 0.4	20 0.5 0.5				
额定控制功率 Power	P							
AC-23A	KW	1.8 3	3.7/2.5 7.5/3.7	5.5/3 11/5.5	7.5/4 15/7.5	15/10 30/18.5	30/15 45/22	37/22 75/37
AC-2	KW	2.5 3.7	4 7.5	5.5 11	7.5 15	18.5 30	30 45	37 55
AC-3	KW	1.5 2.2	3/2.2 5.5/3	4/3 7.5/3.7	5.5/4 11/5.5	11/6 18.5/11	15/7.5 30/13	22/11 37/18.5
AC-4	KW	0.37 0.55	0.55/0.75 1.5/1.5	1.5/1.1 3/2.2	2.7/1.5 5.5/3	5.5/2.4 7.5/4	6/3 12/5.5	10/4 15/7.5

注1: 零线接地;

Re1: Neutral;

注2: AC-23A、AC-3、AC-4额定功率分子表示3相3极, 分母表示1相2极, AC-2为3相3极。

Re2: The power under: AC-23A、AC-3、AC-4 are in three phase three pole, and the denominator represents the power under single phase two poles.

机械寿命和电寿命 Mechanical life

机械寿命: 0.1×10^6 次, 操作频率为 120 次/小时。

Mechanical life without load: 0.1×10^6 times, operation frequency is 120 times/h.

电寿命: 0.03×10^6 次, 操作频率为 120 次/小时。

Mechanical life with load: 0.03×10^6 times operation frequency is 120 times/h.

订货须知 Order procedure

LW26系列万能转换开关和 LW2D、LW5D、LW6D、LW8D、LW12、LW15、HZ5D、HZ25D 开关的操作图(接线图)编号相同, 用户订货时可参照我厂编制的开关操作图进行选用, 如有特殊要求须预先说明或提供操作图。

订货时请注明产品型号规格、面板规格、手柄类型及颜色、数量。

如需订购额定电流为20A, 转换角度为 60° , 特征代号为 C, 操作图编号为 5391, M1圆角方形面板, 黑色R型手柄的 LW26万能转换开关20台, 则订货书写示例为:

LW26-20 · 6C5391/2 A11R (M1 圆角方形面板 黑色R型手柄) 20台

注: 因产品技术需要不断改进, 所有参数应以本厂最新数据为准, 如有变动, 恕不另行通知。

When placing an order please specify the contact diagram of the product you require. The LW26 Series rotary have the similar contact diagram as the other rotary switches like LW2D、LW5D、LW6D、LW8D、LW12、LW15、HZ5D and HZ25D. Our factory have published 《The General Contact Diagram for Cansen Rotary Switches》 Which will help you to specify the contact diagram.

In addition please specify the current rating, mounting plate, handle type, color and quantity as well. For instance:

When ordering 20A, rotary angle 60° , character code C, contact diagram code 5391, M1 plate, black R handle switch 20 units. The order can be:

LW26-20 · 6C5391/2 A11R (M1 R) 20units.

Due to the update of the technologies, we reserve the righting of updating the catalog without further notices.

◆ 外形尺寸和安装尺寸 Dimensions and installation

方形面板和矩形面板 Square escutcheon plate and rectangular escutcheon plate

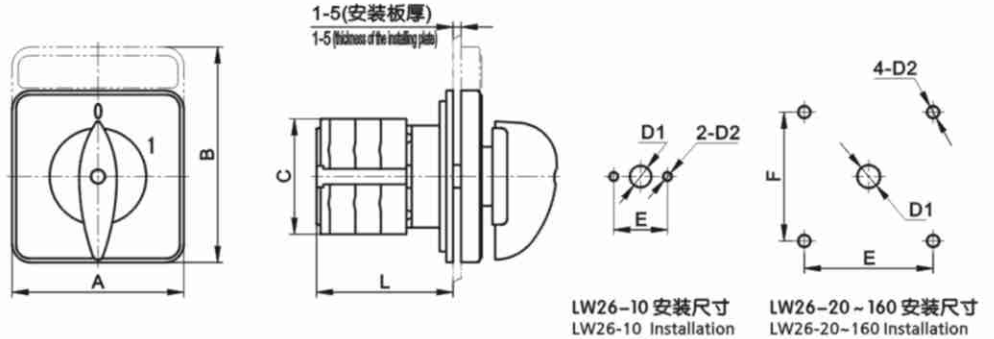

型号规格 Description	面板规格 Escutcheon plate	外形尺寸 Dimensions (mm)				安装尺寸 Installation (mm)			
		A	B	C	L	E	F	D1	D2
LW26-10	M0 方形 M0 square	30	30	28	22+8n	20		∅8	∅3.2
LW26X-10	M0 方形 M0 square	30	30	28	26.5+12n	20		∅8	∅3.2
LW26-20	M1 方形 M1 square	48	48	43	22+9.6n	36	36	∅8.5	∅4.5
	M1 矩形 M1 rectangular	48	60	43	22+9.6n	36	36	∅8.5	∅4.5
	M2 方形 M2 square	64	64	43	25+9.6n	48	48	∅10	∅4.5
LW26c-20	M2 矩形 M2 rectangular	64	80	43	25+9.6n	48	48	∅10	∅4.5
	M2 方形 M2 square	64	64	60	42.5+12.6n	48	48	∅10	∅4.5
	M2 矩形 M2 rectangular	64	80	60	42.5+12.6n	48	48	∅10	∅4.5
LW26-25	M3 方形 M3 square	88	88	60	42.5+12.6n	68	68	∅13	∅6
	M1 方形 M1 square	48	48	45.2	23+12.8n	36	36	∅8.5	∅4.5
	M1 矩形 M1 rectangular	48	60	45.2	23+12.8n	36	36	∅8.5	∅4.5
LW26-32	M2 方形 M2 square	64	64	45.2	26.5+12.8n	48	48	∅10	∅4.5
	M2 矩形 M2 rectangular	64	80	45.2	26.5+12.8n	48	48	∅10	∅4.5
	M3 方形 M3 square	88	88	58	29.2+12.8n	48	48	∅10	∅4.5
LW26-32F	M2 矩形 M2 rectangular	64	80	58	29.2+12.8n	48	48	∅10	∅4.5
	M3 方形 M3 square	88	88	58	29.2+12.8n	68	68	∅13	∅6
	M1 方形 M1 square	48	48	48	23+14n	36	36	∅8.5	∅4.5
LW26-63	M1 矩形 M1 rectangular	48	60	48	23+14n	36	36	∅8.5	∅4.5
	M2 方形 M2 square	64	64	48	24.5+14n	48	48	∅10	∅4.5
	M2 矩形 M2 rectangular	64	80	48	24.5+14n	48	48	∅10	∅4.5
LW26-125	M2 方形 M2 square	64	64	66	29.2+21.5n	48	48	∅10	∅4.5
	M2 矩形 M2 rectangular	64	80	66	29.2+21.5n	48	48	∅10	∅4.5
	M3 方形 M3 square	88	88	66	29.2+21.5n	68	68	∅13	∅6
LW26-160	M3 方形 M3 square	88	88	84	35+26.5n	68	68	∅13	∅6
LW26-160	M3 方形 M3 square	88	88	88	35+32.5n	68	68	∅13	∅6

注：n为接触系统节数，下同。
Re: n for number of layers.

◆ 特殊型号与附件 Special type and optional extras

单孔安装 Single hole installation

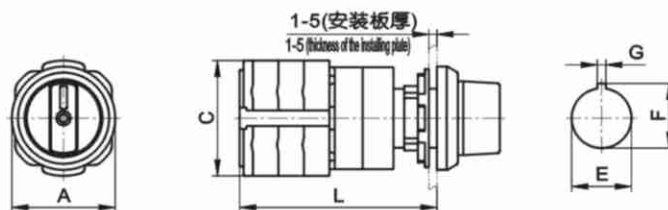

型号规格 Description	外形尺寸 Dimensions (mm)			安装尺寸 Installation (mm)			手柄类型 Type of handle		
	A	C	L	E	F	G	I	B	F
LW26-10	∅29	28	35+8n	∅16.2	18	1.9	●		●
LW26X-10	∅29	28	39+12n	∅16.2	18	1.9	●		●
LW26-20	∅39	43	42+9.6n	∅22.3	24.1	3.2	●	●	●
LW26-20	∅39	43	42+9.6n	∅30.5	33	4.8	●	●	●
LW26-25	∅39	45.2	42+12.8n	∅22.3	24.1	3.2	●	●	●
LW26-25	∅39	45.2	42+12.8n	∅30.5	33	4.8	●	●	●
LW26-32F	∅39	48	42+14n	∅22.3	24.1	3.2	●	●	●
LW26-32F	∅39	48	42+14n	∅30.5	33	4.8	●	●	●

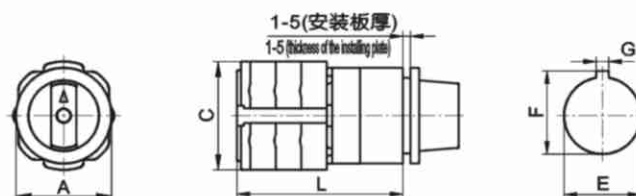

型号规格 Description	外形尺寸 Dimensions (mm)			安装尺寸 Installation (mm)		
	A	C	L	E	F	G
LW26-20	∅39	43	35+9.6n	∅30.5	33	4.8
LW26-25	∅39	45.2	35+12.8n	∅30.5	33	4.8
LW26-32F	∅39	48	35+14n	∅30.5	33	4.8

单孔带面板安装 Single hole with installation plate

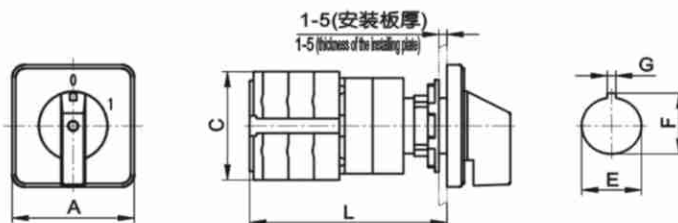

型号规格 Description	面板规格 Escutcheon plate	外形尺寸 Dimensions (mm)			安装尺寸 Installation (mm)			手柄类型 Type of handle		
		A	C	L	E	F	G	I	B	F
LW26-10	M0 方形 M0 square	□30	28	35+8n	∅16.2	18	1.9	●		●
LW26X-10	M0 方形 M0 square	□30	28	39+12n	∅16.2	18	1.9	●		●
LW26-20	M1 方形 M1 square	□48	43	42+9.6n	∅22.3	24.1	3.2	●	●	●
LW26-20	M1 方形 M1 square	□48	43	42+9.6n	∅30.5	33	4.8	●	●	●
LW26-25	M1 方形 M1 square	□48	45.2	42+12.8n	∅22.3	24.1	3.2	●	●	●
LW26-25	M1 方形 M1 square	□48	45.2	42+12.8n	∅30.5	33	4.8	●	●	●
LW26-32F	M1 方形 M1 square	□48	48	42+14n	∅22.3	24.1	3.2	●	●	●
LW26-32F	M1 方形 M1 square	□48	48	42+14n	∅30.5	33	4.8	●	●	●

双孔安装 Double hole installation

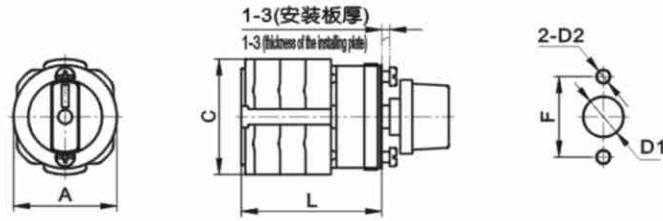

型号规格 Description	外形尺寸 Dimensions (mm)			安装尺寸 Installation (mm)		
	A	C	L	F	D1	D2
LW26-20	39	43	24+9.6n	30	∅15	∅5
LW26-25	39	45.2	25+12.8n	30	∅15	∅5
LW26-32F	39	48	25+14n	30	∅15	∅5

内嵌螺母安装 Embed brass nut installation

注：用户应指定选用哪种安装方式

Re: customers should select the installation method which is suitable

安装方式一

Installation method one

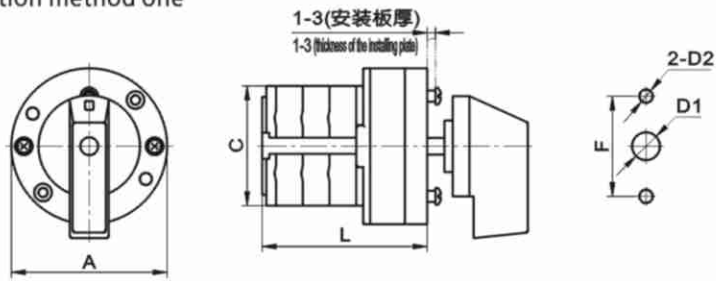

安装方式二

Installation method two

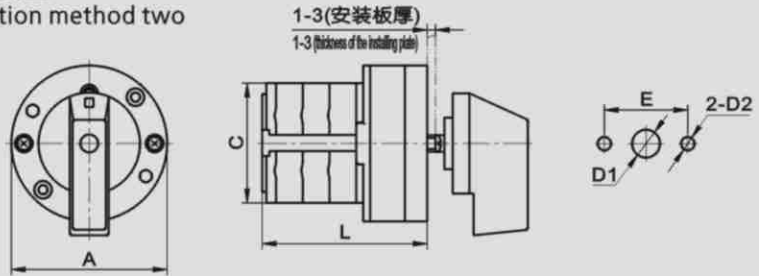

安装方式三

Installation method three

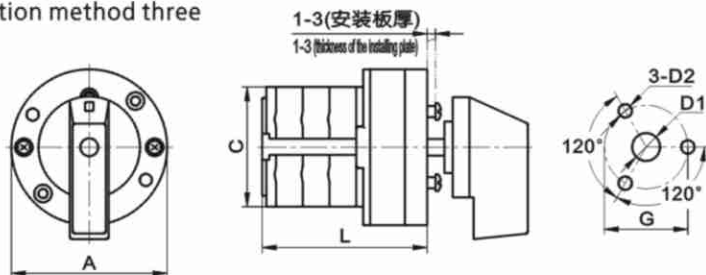

型号规格 Description	外形尺寸 Dimensions (mm)			安装尺寸 Installation (mm)				
	A	C	L	E	F	G	D1	D2
LW26-20	∅56	43	31+9.6n	30	36	∅30	∅10	∅4.5
LW26c-20	∅60	60	30+12.6n	30	36	∅30	∅10	∅4.5
LW26-25	∅56	45.2	32+12.8n	30	36	∅30	∅10	∅4.5
LW26-32	∅56	58	30+12.8n	30	36	∅30	∅10	∅4.5
LW26-32F	∅56	48	32+14n	30	36	∅30	∅10	∅4.5
LW26-63	∅56	66	30+21.5n	30	36	∅30	∅10	∅4.5



双孔安装距离可微调安装 Double holes flexible installation

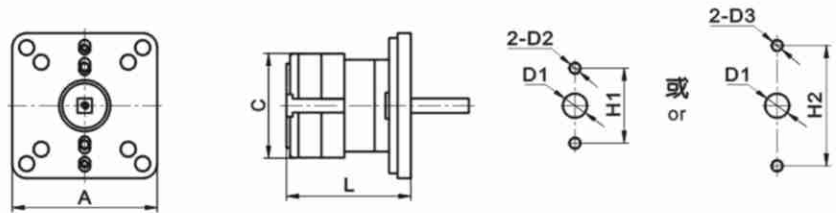

型号规格 Description	外形尺寸 Dimensions (mm)			安装尺寸 Installation (mm)				
	A	C	L	H1	H2	D1	D2	D3
LW26-20	□60	43	26+9.6n	30~36	47~50	∅10	∅3.5	∅4.5
LW26c-20	□60	60	31+12.6n	30~36	47~50	∅10	∅3.5	∅4.5
LW26-25	□60	45.2	27+12.8n	30~36	47~50	∅10	∅3.5	∅4.5
LW26-32F	□60	48	27+14n	30~36	47~50	∅10	∅3.5	∅4.5
LW26-32	□60	58	31+12.8n	30~36	47~50	∅10	∅3.5	∅4.5
LW26-63	□60	66	31+21.5n	30~36	47~50	∅10	∅3.5	∅4.5



导轨安装 Parallel installation

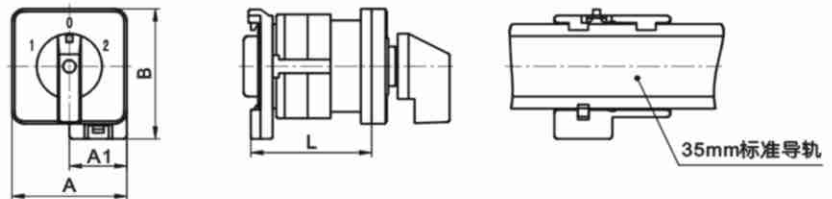

型号规格 Description	外形尺寸 Dimensions (mm)				安装尺寸 Installation (mm)
	A	A1	B	L	
LW26-20	□48	24	54	31+9.6n	35mm标准导轨
LW26-25	□48	24	54	32+12.8n	35mm标准导轨
LW26-32F	□48	24	54	32+14n	35mm标准导轨



底座安装 Base installation

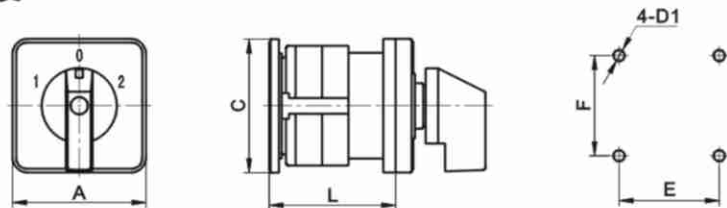

型号规格 Description	外形尺寸 Dimensions (mm)			安装尺寸 Installation (mm)		
	A	C	L	E	F	D1
LW26-20	□48	48	26.5+9.6n	36	36	∅4.5
LW26c-20	□64	64	35+12.6n	48	48	∅4.5
LW26-25	□48	48	27.5+12.8n	36	36	∅4.5
LW26-32	□64	64	33+12.8n	48	48	∅4.5
LW26-32F	□48	64	27.5+14n	48	48	∅4.5
LW26-63	□64	64	33+21.5n	48	48	∅4.5
LW26-125	□88	88	42+26.5n	64	64	∅6
LW26-160	□88	88	42+32n	64	64	∅6



带Q型 Q Type

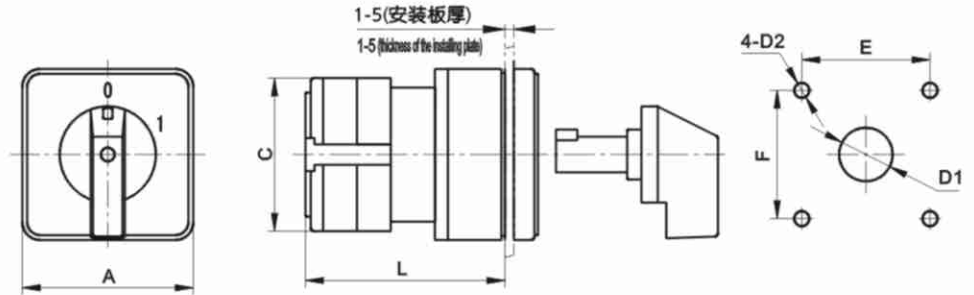

型号规格 Description	面板规格 Escutcheon plate	外形尺寸 Dimensions (mm)			安装尺寸 Installation (mm)			
		A	C	L	E	F	D1	D2
LW26-20	M1 方形 M1 square	48	43	38+9.6n	36	36	∅15	∅4.2
LW26-25	M1 方形 M1 square	48	45.2	39+12.8n	36	36	∅15	∅4.2
LW26-32F	M1 方形 M1 square	48	48	39+14n	36	36	∅15	∅4.2

带指示灯 Indicating light

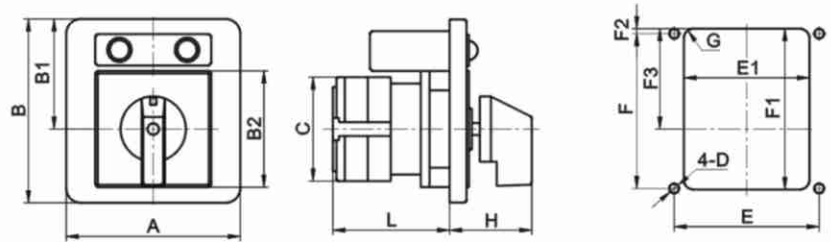

型号规格 Description	外形尺寸 Dimensions (mm)							安装尺寸 Installation (mm)							
	A	B	B1	B2	C	L	H	E	E1	F	F1	F2	F3	D	G
LW26-20	72	76	45.5	48	43	26+9.6n	34max	60	52	64	66.5	2	41.5	∅4	R4
LW26-25	72	76	45.5	48	45.2	26+12.8n	34max	60	52	64	66.5	2	41.5	∅4	R4
LW26-32F	72	76	45.5	48	48	26+14n	34max	60	52	64	66.5	2	41.5	∅4	R4

带灯带锁 Indicating light with keylock

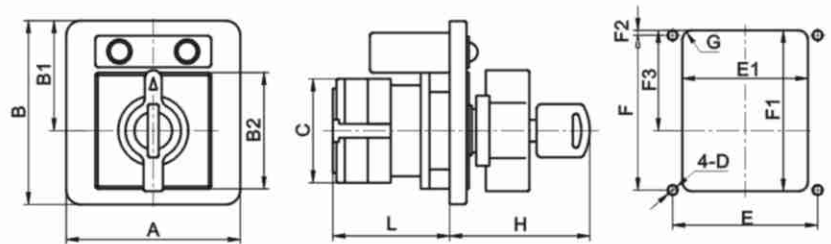

型号规格 Description	外形尺寸 Dimensions (mm)							安装尺寸 Installation (mm)							
	A	B	B1	B2	C	L	H	E	E1	F	F1	F2	F3	D	G
LW26-20	72	76	45.5	48	43	26+9.6n	58max	60	52	64	66.5	2	41.5	∅4	R4
LW26-25	72	76	45.5	48	45.2	26+12.8n	58max	60	52	64	66.5	2	41.5	∅4	R4
LW26-32F	72	76	45.5	48	48	26+14n	58max	60	52	64	66.5	2	41.5	∅4	R4

快速转换开关 Quick-moving switch

快速转换开关由快速转换机构进行储能，通过瞬间释能实现开关的快速转换，且转换过程完全由快速转换机构控制，不受人员操作影响。开关转换过程迅速、稳定、可靠，适用于有载电路和直流电路。

Quick-moving rotary switch operated by quick-moving mechanism. During the operation, switch handle can be rotated against the force of the energy-storage mechanism, and the shaft rotates until the energy-storage mechanism releases. So make the close and open of the contacts quickly. And during the rotation (the close or/and open of the contacts) is controlled by the quick-moving mechanism, and would not be affected by the operator.

The quick-moving rotary switch rotates quick, stable and reliable, suitable for on load change-over or direct current system.



安装方式一

Installation method one

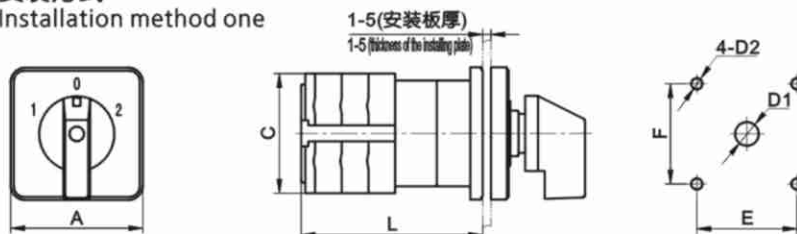

型号规格 Description	面板规格 Escutcheon plate	外形尺寸 Dimensions (mm)			安装尺寸 Installation (mm)			
		A	C	L	E	F	D1	D2
LW26-20	M1方形 M1 square	48	43	37+9.6n	36	36	∅8.5	∅4.5
LW26-20	M2方形 M2 square	64	43	38+9.6n	48	48	∅10	∅4.5
LW26-25	M1方形 M1 square	48	45.2	38+12.8n	36	36	∅8.5	∅4.5
LW26-25	M2方形 M2 square	64	45.2	39+12.8n	48	48	∅10	∅4.5
LW26-32F	M1方形 M1 square	48	48	38+14n	36	36	∅8.5	∅4.5
LW26-32F	M2方形 M2 square	64	48	39+14n	48	48	∅10	∅4.5

安装方式二

Installation method two

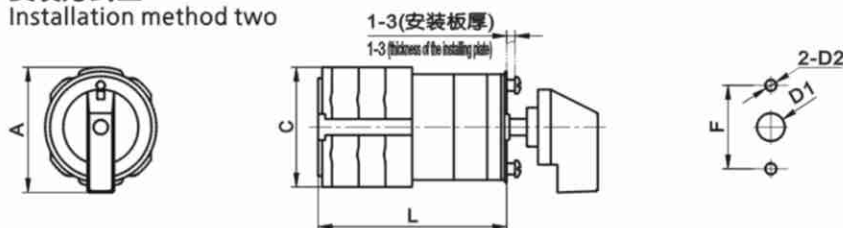

型号规格 Description	外形尺寸 Dimensions (mm)			安装尺寸 Installation (mm)		
	A	C	L	F	D1	D2
LW26-20	45	43	39+9.6n	30	∅10	∅4.5
LW26-25	46	45.2	31+12.8n	30	∅10	∅4.5
LW26-32F	48	48	31+14n	30	∅10	∅4.5



LS型 LS type

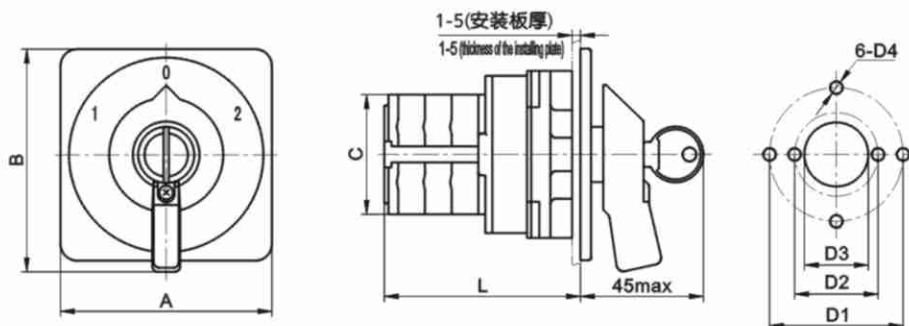

型号规格 Description	外形尺寸 Dimensions (mm)				安装尺寸 Installation (mm)			
	A	B	C	L	D1	D2	D3	D4
LW26-20	76	80	43	31+9.6n	∅48	∅30	∅23	∅4.5
LW26-25	76	80	45.2	32+12.8n	∅48	∅30	∅23	∅4.5
LW26-32	76	80	58	30+12.8n	∅48	∅30	∅23	∅4.5
LW26-32F	76	80	48	32+14n	∅48	∅30	∅23	∅4.5
LW26-63	76	80	66	30+21.5n	∅48	∅30	∅23	∅4.5



单推锁 Single lock

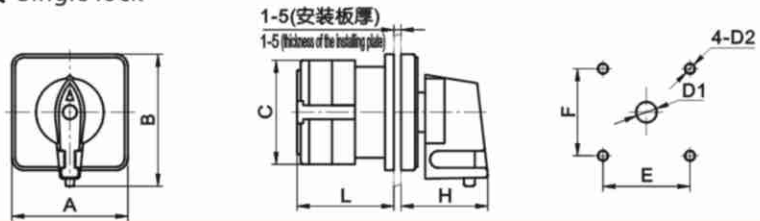

型号规格 Description	外形尺寸 Dimensions (mm)					安装尺寸 Installation (mm)			
	A	B	C	L	H	E	F	D1	D2
LW26-20	□48	55	43	22+9.6n	36max	36	36	∅8.5	∅4.5
LW26-25	□48	55	45.2	25+12.8n	36max	36	36	∅8.5	∅4.5
LW26-32F	□48	55	48	23+14n	36max	36	36	∅8.5	∅4.5

加强限位 Reinforced limited movement type

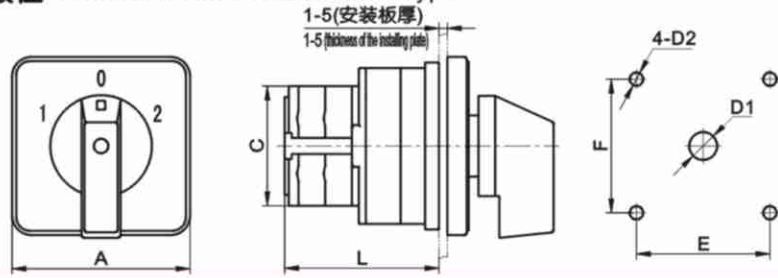

型号规格 Description	外形尺寸 Dimensions (mm)			安装尺寸 Installation (mm)			
	A	C	L	E	F	D1	D2
LW26-20	□64	43	36+9.6n	48	48	∅10	∅4.5
LW26c-20	□64	60	36+12.6n	48	48	∅10	∅4.5
LW26-25	□64	45.2	37.5+12.8n	48	48	∅10	∅4.5
LW26-32	□64	58	36+12.8n	48	48	∅10	∅4.5
LW26-32F	□64	48	37.5+14n	48	48	∅10	∅4.5
LW26-63	□64	66	36+21.5n	48	48	∅10	∅4.5

引出式 Put out type

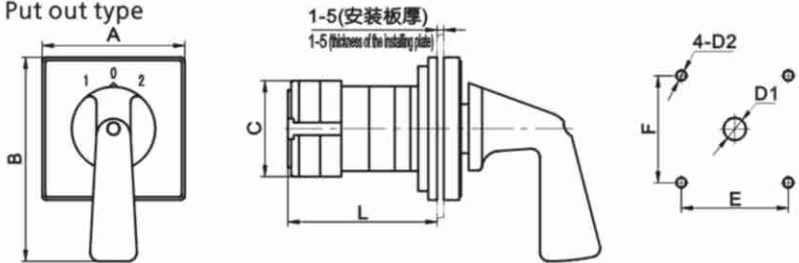

型号规格 Description	外形尺寸 Dimensions (mm)				安装尺寸 Installation (mm)			
	A	B	C	L	E	F	D1	D2
LW26-20	64	91.5	43	48+9.6n	48	48	∅10	∅4.5
LW26-25	64	91.5	45.2	49+12.8n	48	48	∅10	∅4.5
LW26-32F	64	91.5	48	49+14n	48	48	∅10	∅4.5

大角度自复 Multi-position spring return

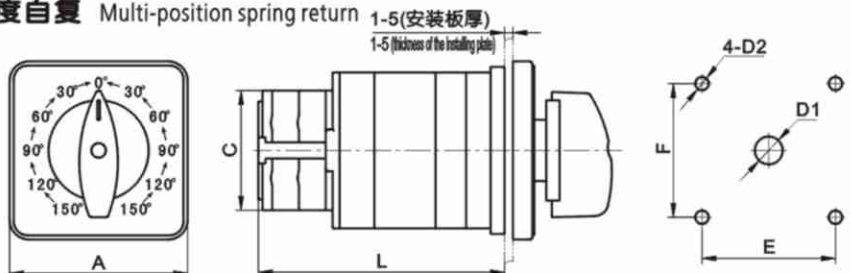

型号规格 Description	外形尺寸 Dimensions (mm)			安装尺寸 Installation (mm)			
	A	C	L	E	F	D1	D2
LW26-20	□64	43	70+9.6n	48	48	∅10	∅4.5
LW26c-20	□64	60	69+12.6n	48	48	∅10	∅4.5
LW26-25	□64	45.2	71+12.8n	48	48	∅10	∅4.5
LW26-32	□64	58	69+12.8n	48	48	∅10	∅4.5
LW26-32F	□64	48	71+14n	48	48	∅10	∅4.5
LW26-63	□64	66	69+21.5n	48	48	∅10	∅4.5



棘轮定位自复 Ratchet limited movement with spring return

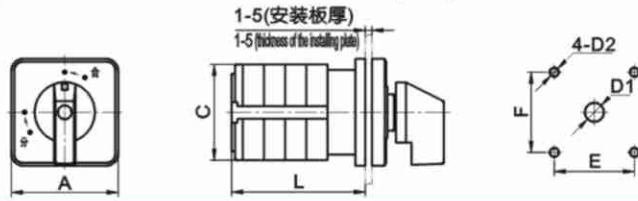

型号规格 Description	外形尺寸 Dimensions (mm)			安装尺寸 Installation (mm)			
	A	C	L	E	F	D1	D2
LW26-20	□48	43	31.5+9.6n	36	36	∅8.5	∅4.5
LW26-25	□48	45.2	36+12.8n	36	36	∅8.5	∅4.5

自复盘定位自复 Limited movement with spring return plate

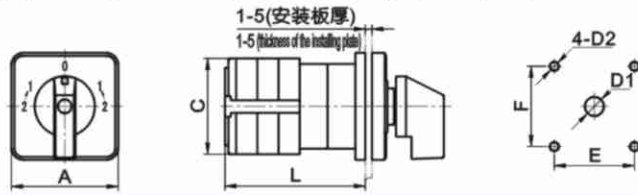

型号规格 Description	外形尺寸 Dimensions (mm)			安装尺寸 Installation (mm)			
	A	C	L	E	F	D1	D2
LW26-20	□48	43	34.5+9.6n	36	36	∅8.5	∅4.5
LW26-25	□48	45.2	35.5+12.8n	36	36	∅8.5	∅4.5

多位自复 Spring return with multiple position

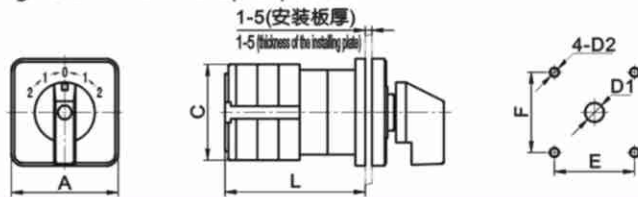

型号规格 Description	外形尺寸 Dimensions (mm)			安装尺寸 Installation (mm)			
	A	C	L	E	F	D1	D2
LW26-20	□48	43	34.5+9.6n	36	36	∅8.5	∅4.5
LW26-25	□48	45.2	35.5+12.8n	36	36	∅8.5	∅4.5

门互锁 Door inter-lock

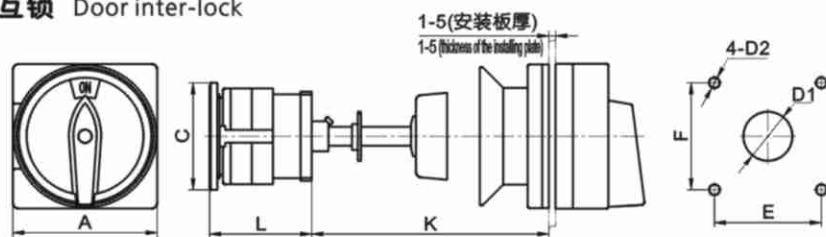

型号规格 Description	外形尺寸 Dimensions (mm)				安装尺寸 Installation (mm)			
	A	C	L	K	E	F	D1	D2
LW26-20	□66	48	27+9.6n	150	36	36	∅22	∅4.5
LW26-25	□66	48	28+12.8n	150	36	36	∅22	∅4.5
LW26-32	□66	64	37.5+12.8n	150	48	48	∅22	∅4.5
LW26-32F	□66	64	28+14n	150	48	48	∅22	∅4.5
LW26-63	□66	64	37.5+21.5n	150	48	48	∅22	∅4.5

防护软壳 Soft plastic protective box

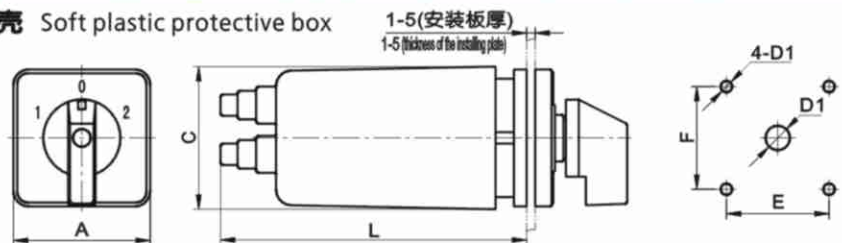

型号规格 Description	外形尺寸 Dimensions (mm)			安装尺寸 Installation (mm)				节数 Stages
	A	C	L	E	F	D1	D2	
LW26-20	□48	50	67.5	36	36	∅8.5	∅4.5	1-3
LW26-20	□48	50	96.5	36	36	∅8.5	∅4.5	1-6



防护外壳 Protective box

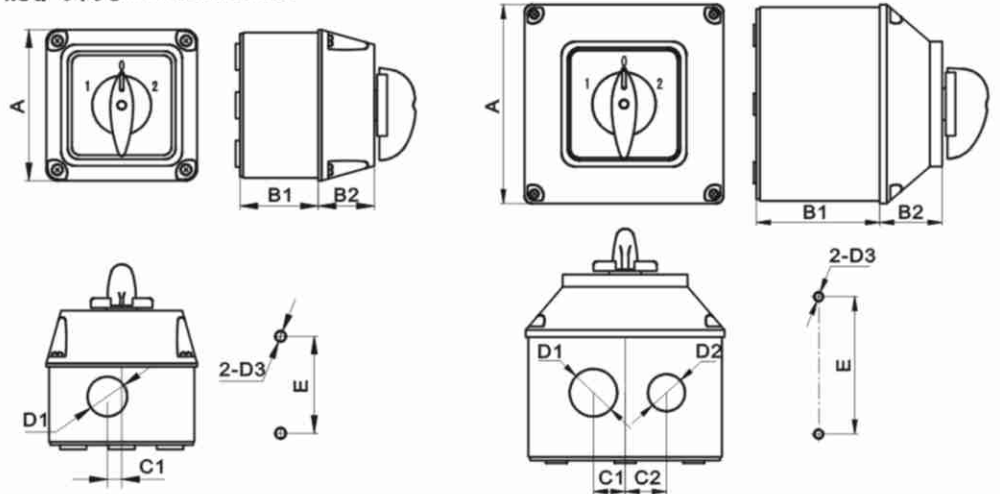

型号规格 Description	外形尺寸 Dimensions (mm)					安装尺寸 Installation (mm)				节数 Stages	备注 Remarks
	A	B1	B2	C1	C2	D1	D2	D3	E		
LW26-20	□68.5	35.5	25.5	6.5		∅18		∅5	44	1-2	
LW26-20	□68.5	45	25.5	6.5		∅18		∅5	44	1-3	
LW26-20	□68.5	35.5	32.5	6.5		∅18		∅5	44	1	单孔型 Single hole
LW26-20	□68.5	45	32.5	6.5		∅18		∅5	44	1-2	单孔型 Single hole
LW26-20	□113	70.5	35.5	18	23.5	∅27	∅21	∅5	78	1-7	
LW26-25	□68.5	35.5	25.5	6.5		∅18		∅5	44	1	
LW26-25	□68.5	45	25.5	6.5		∅18		∅5	44	1-2	
LW26-25	□68.5	35.5	32.5	6.5		∅18		∅5	44	1	单孔型 Single hole
LW26-25	□68.5	45	32.5	6.5		∅18		∅5	44	1	单孔型 Single hole
LW26-25	□113	70.5	35.5	18	23.5	∅27	∅21	∅5	78	1-5	
LW26-32F	□68.5	35.5	25.5	6.5		∅18		∅5	44	1	
LW26-32F	□68.5	45	25.5	6.5		∅18		∅5	44	1-2	
LW26-32F	□68.5	35.5	32.5	6.5		∅18		∅5	44	1	单孔型 Single hole
LW26-32F	□68.5	45	32.5	6.5		∅18		∅5	44	1	单孔型 Single hole
LW26-32F	□113	70.5	35.5	18	23.5	∅27	∅21	∅5	78	1-4	
LW26-32	□113	70.5	35.5	18	23.5	∅27	∅21	∅5	78	1-4	
LW26-63	□113	70.5	35.5	18	23.5	∅27	∅21	∅5	78	1-2	

防护罩 Protective cover

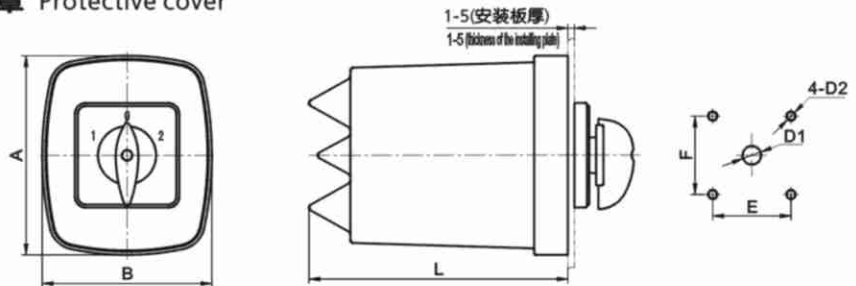

型号规格 Description	外形尺寸 Dimensions (mm)			安装尺寸 Installation (mm)				节数 Stages
	A	B	L	E	F	D1	D2	
LW26-20	91.5	78	195	36	36	∅8.5	∅4.5	1-6
LW26-25	91.5	78	195	36	36	∅8.5	∅4.5	1-5
LW26-32F	91.5	78	195	36	36	∅8.5	∅4.5	1-4

防护铁壳 Protective iron box

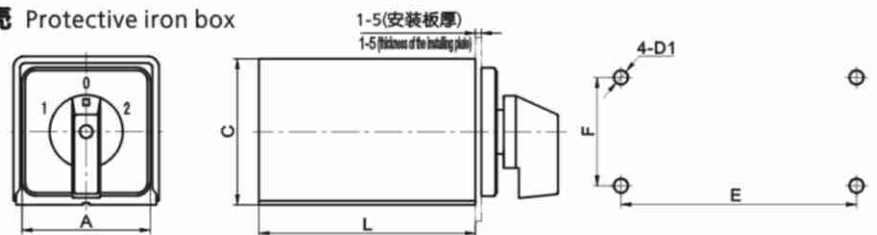

型号规格 Description	外形尺寸 Dimensions (mm)			安装尺寸 Installation (mm)			节数 Stages
	A	C	L	E	F	D1	
LW26-20	□64	74	108	69.5	54	∅7	1-6
LW26-25	□64	74	108	69.5	54	∅7	1-6
LW26-32	□64	74	108	69.5	54	∅7	1-4
LW26-32F	□64	74	108	69.5	54	∅7	1-4

◆ 开关功能、操作图 Selection of typical contact diagrams

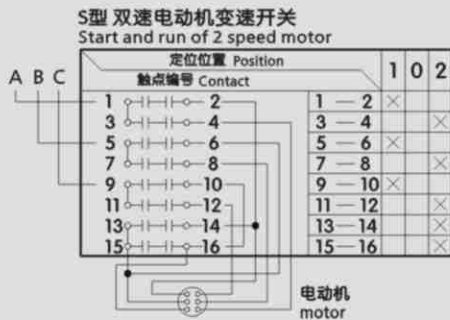
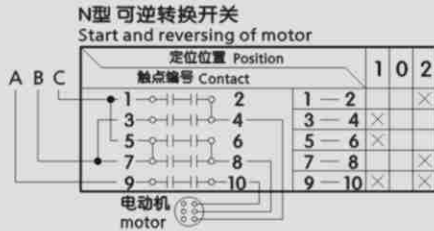
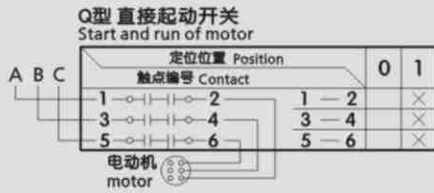

电动机 motor
无限位装置
(用户如需要限位订货时请注明)
without limiting devices
customers should inform as in case of necessary

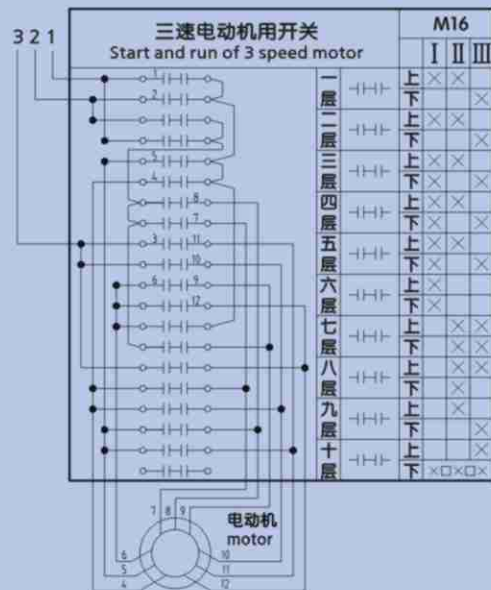
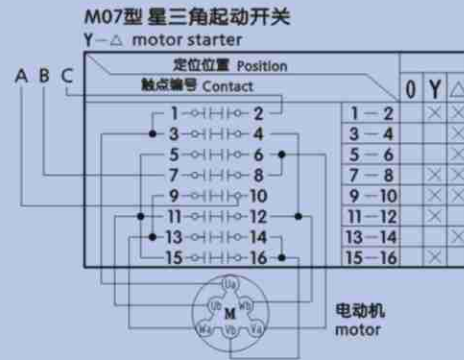
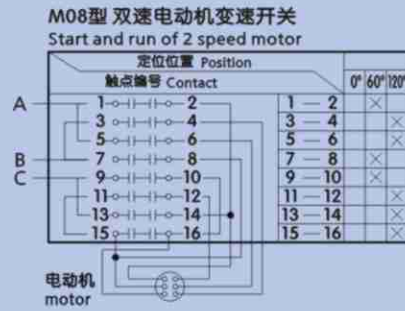

◆ 特殊型号与附件 例图 Special type and optional extras Figure

注: ● 为适用的开关型号规格。
Re: ● Products where suitable

LW26-10 斜插 Product with angled terminals



- 适用型号 Applicable Type
- LW26-10 ●
 - LW26X-10 ●
 - LW26-20 ●
 - LW26c-20 ●
 - LW26-25 ●
 - LW26-32 ●
 - LW26-32F ●
 - LW26-63 ●
 - LW26-125 ●
 - LW26-160 ●



- 适用型号 Applicable Type
- LW26-10 ●
 - LW26X-10 ●
 - LW26-20 ●
 - LW26c-20 ●
 - LW26-25 ●
 - LW26-32 ●
 - LW26-32F ●
 - LW26-63 ●
 - LW26-125 ●
 - LW26-160 ●

LW26-10 □ • A10I

LW26X-10 □ • A10I

LW26X-10 □ • C55F

32A 护指 32A Finger protection

LS型 LS type



- 适用型号 Applicable Type
- LW26-10 ●
 - LW26X-10 ●
 - LW26-20 ●
 - LW26c-20 ●
 - LW26-25 ●
 - LW26-32 ●
 - LW26-32F ●
 - LW26-63 ●
 - LW26-125 ●
 - LW26-160 ●



- 适用型号 Applicable Type
- LW26-10 ●
 - LW26X-10 ●
 - LW26-20 ●
 - LW26c-20 ●
 - LW26-25 ●
 - LW26-32 ●
 - LW26-32F ●
 - LW26-63 ●
 - LW26-125 ●
 - LW26-160 ●

LW26-32F □ • A11I

LW26-32F □ • C55I

LW26-32F □ • C51S1

LW26-20 □ • A12LS

单推锁 Single lock

带指示灯 Indicating light

带灯带锁 Indicating light with keylock



- 适用型号 Applicable Type
- LW26-10 ●
 - LW26X-10 ●
 - LW26-20 ●
 - LW26c-20 ●
 - LW26-25 ●
 - LW26-32 ●
 - LW26-32F ●
 - LW26-63 ●
 - LW26-125 ●
 - LW26-160 ●



- 适用型号 Applicable Type
- LW26-10 ●
 - LW26X-10 ●
 - LW26-20 ●
 - LW26c-20 ●
 - LW26-25 ●
 - LW26-32 ●
 - LW26-32F ●
 - LW26-63 ●
 - LW26-125 ●
 - LW26-160 ●



- 适用型号 Applicable Type
- LW26-10 ●
 - LW26X-10 ●
 - LW26-20 ●
 - LW26c-20 ●
 - LW26-25 ●
 - LW26-32 ●
 - LW26-32F ●
 - LW26-63 ●
 - LW26-125 ●
 - LW26-160 ●

LW26-25 □ • A11DS

LW26-20 □ • A66I

LW26-25 □ • A66S1

B型手柄 B Type handle

加强限位 Reinforced limited movement type



- 适用型号 Applicable Type
- LW26-10 ●
 - LW26X-10 ●
 - LW26-20 ●
 - LW26c-20 ●
 - LW26-25 ●
 - LW26-32 ●
 - LW26-32F ●
 - LW26-63 ●
 - LW26-125 ●
 - LW26-160 ●



- 适用型号 Applicable Type
- LW26-10 ●
 - LW26X-10 ●
 - LW26-20 ●
 - LW26c-20 ●
 - LW26-25 ●
 - LW26-32 ●
 - LW26-32F ●
 - LW26-63 ●
 - LW26-125 ●
 - LW26-160 ●

LW26-25 □ • C55B

LW26-20 □ • C55B

LW26-20 □ • A32I7

双孔安装 Double hole installation

底座安装 Base installation

导轨安装 Parallel installation



- 适用型号 Applicable Type
- LW26-10 ●
 - LW26X-10 ●
 - LW26-20 ●
 - LW26c-20 ●
 - LW26-25 ●
 - LW26-32 ●
 - LW26-32F ●
 - LW26-63 ●
 - LW26-125 ●
 - LW26-160 ●



- 适用型号 Applicable Type
- LW26-10 ●
 - LW26X-10 ●
 - LW26-20 ●
 - LW26c-20 ●
 - LW26-25 ●
 - LW26-32 ●
 - LW26-32F ●
 - LW26-63 ●
 - LW26-125 ●
 - LW26-160 ●



- 适用型号 Applicable Type
- LW26-10 ●
 - LW26X-10 ●
 - LW26-20 ●
 - LW26c-20 ●
 - LW26-25 ●
 - LW26-32 ●
 - LW26-32F ●
 - LW26-63 ●
 - LW26-125 ●
 - LW26-160 ●

LW26-25 □ • G88B

LW26-25 □ • B11R

LW26-20 □ • D11R

单孔安装 Single hole installation



- 适用型号 Applicable Type
- LW26-10 ●
 - LW26X-10 ●
 - LW26-20 ●
 - LW26c-20 ●
 - LW26-25 ●
 - LW26-32 ●
 - LW26-32F ●
 - LW26-63 ●
 - LW26-125 ●
 - LW26-160 ●

LW26X-10 □ • C10I

LW26-20 □ • C55S1

LW26-25 □ • C55I

LW26-20 □ • C11B

LW26-32F □ • C11I

定位自复 Spring return with limited movement
多位自复 Spring return with multiple position
引出式 Put out type

适用型号 Applicable Type
LW26-10
LW26X-10
LW26-20
LW26c-20
LW26-25
LW26-32
LW26-32F
LW26-63
LW26-125
LW26-160

 LW26-20 • A11R

 LW26-20 • A11R

适用型号 Applicable Type
LW26-10
LW26X-10
LW26-20
LW26c-20
LW26-25
LW26-32
LW26-32F
LW26-63
LW26-125
LW26-160

 LW26-20 • A32P1

适用型号 Applicable Type
LW26-10
LW26X-10
LW26-20
LW26c-20
LW26-25
LW26-32
LW26-32F
LW26-63
LW26-125
LW26-160

矩形面板 Rectangle plate
大角度自复 Multi-position spring return

 LW26-20 • A21R

 LW26-20 • A41I

 LW26-63 • A42I

适用型号 Applicable Type
LW26-10
LW26X-10
LW26-20
LW26c-20
LW26-25
LW26-32
LW26-32F
LW26-63
LW26-125
LW26-160

 LW26c-20 • A12L6

适用型号 Applicable Type
LW26-10
LW26X-10
LW26-20
LW26c-20
LW26-25
LW26-32
LW26-32F
LW26-63
LW26-125
LW26-160

带 Q 型 Q Type
门互锁 Door inter-lock

 LW26-20 • A11I4

 LW26-25 • A31I4

 LW26-32F • A11I4

适用型号 Applicable Type
LW26-10
LW26X-10
LW26-20
LW26c-20
LW26-25
LW26-32
LW26-32F
LW26-63
LW26-125
LW26-160

 LW26-63 • K32GS

适用型号 Applicable Type
LW26-10
LW26X-10
LW26-20
LW26c-20
LW26-25
LW26-32
LW26-32F
LW26-63
LW26-125
LW26-160

直流电源 Special type for DC circuits
防护罩 Protective cover
防护铁壳 Protective iron box

 LW26-25 • A11R2

适用型号 Applicable Type
LW26-10
LW26X-10
LW26-20
LW26c-20
LW26-25
LW26-32
LW26-32F
LW26-63
LW26-125
LW26-160

 LW26-20 • F11R

适用型号 Applicable Type
LW26-10
LW26X-10
LW26-20
LW26c-20
LW26-25
LW26-32
LW26-32F
LW26-63
LW26-125
LW26-160

 LW26-20 • T32I

适用型号 Applicable Type
LW26-10
LW26X-10
LW26-20
LW26c-20
LW26-25
LW26-32
LW26-32F
LW26-63
LW26-125
LW26-160

防护外壳 Protective box

 LW26-20 • E31I

 LW26-20 • E31GS

 LW26-20 • E11S1

 LW26-20 • E11DS

 LW26-32 • E12R

适用型号 Applicable Type
LW26-10
LW26X-10
LW26-20
LW26c-20
LW26-25
LW26-32
LW26-32F
LW26-63
LW26-125
LW26-160

内嵌螺母安装 Embed brass nut installation
双孔安装距离可微调安装 Double holes flexible installation
快速转换开关 Quick-moving switch

 LW26-63 • J88I

适用型号 Applicable Type
LW26-10
LW26X-10
LW26-20
LW26c-20
LW26-25
LW26-32
LW26-32F
LW26-63
LW26-125
LW26-160

 LW26-32F • L82I4

适用型号 Applicable Type
LW26-10
LW26X-10
LW26-20
LW26c-20
LW26-25
LW26-32
LW26-32F
LW26-63
LW26-125
LW26-160

 LW26-20 • G85I3

适用型号 Applicable Type
LW26-10
LW26X-10
LW26-20
LW26c-20
LW26-25
LW26-32
LW26-32F
LW26-63
LW26-125
LW26-160