

Motor protective circuit breakers Ex9S32A



- Manual motor protective circuit breakers
- Meet requirements of IEC/EN 60947-2 and IEC/EN 60947-4-1
- Rated current I_n up to 32 A at 415 V AC-3
- Rated operating voltage U_n up to 690V
- Overload, short-circuit and phase-failure protection
- Ambient temperature compensation
- Single frame size suitable also for distribution boards with 45 mm cutout
- Wide range of accessories

Manual motor protective circuit breakers Ex9S32A provide overload, short-circuit and phase-failure protection for the three-phase asynchronous motors with not frequent starting. They are also suitable for power distribution line protection or can be used simply as an isolator.

The right setting of adjustable overload current allows to optimize motor protection by means of circuit breaker. In case of 3P application, correct setting of I_r provides also protection against overload caused due to a phase lost. Ambient temperature compensation function reduces the impact of ambient temperature. Release testing mechanism enables to test the function of the system and control rotary knob lock mechanism prevents illegal operation.

Motor protective circuit breakers can be combined with wide range of accessories including auxiliary and signal contacts, shunt trip and undervoltage releases. It is possible to create diverse combination of accessories.

Type Key

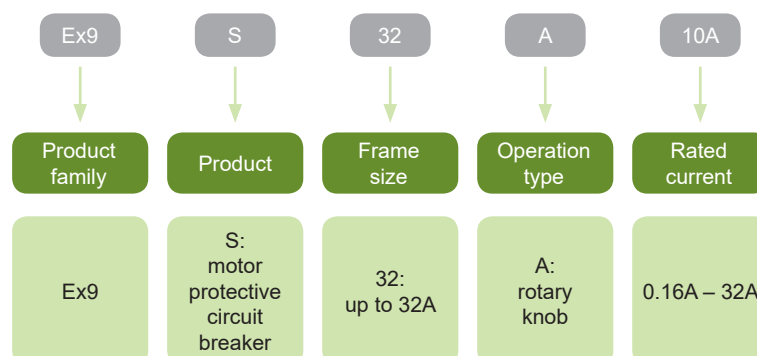

Certification marks



Motor protective circuit breakers Ex9S32A

Accessories

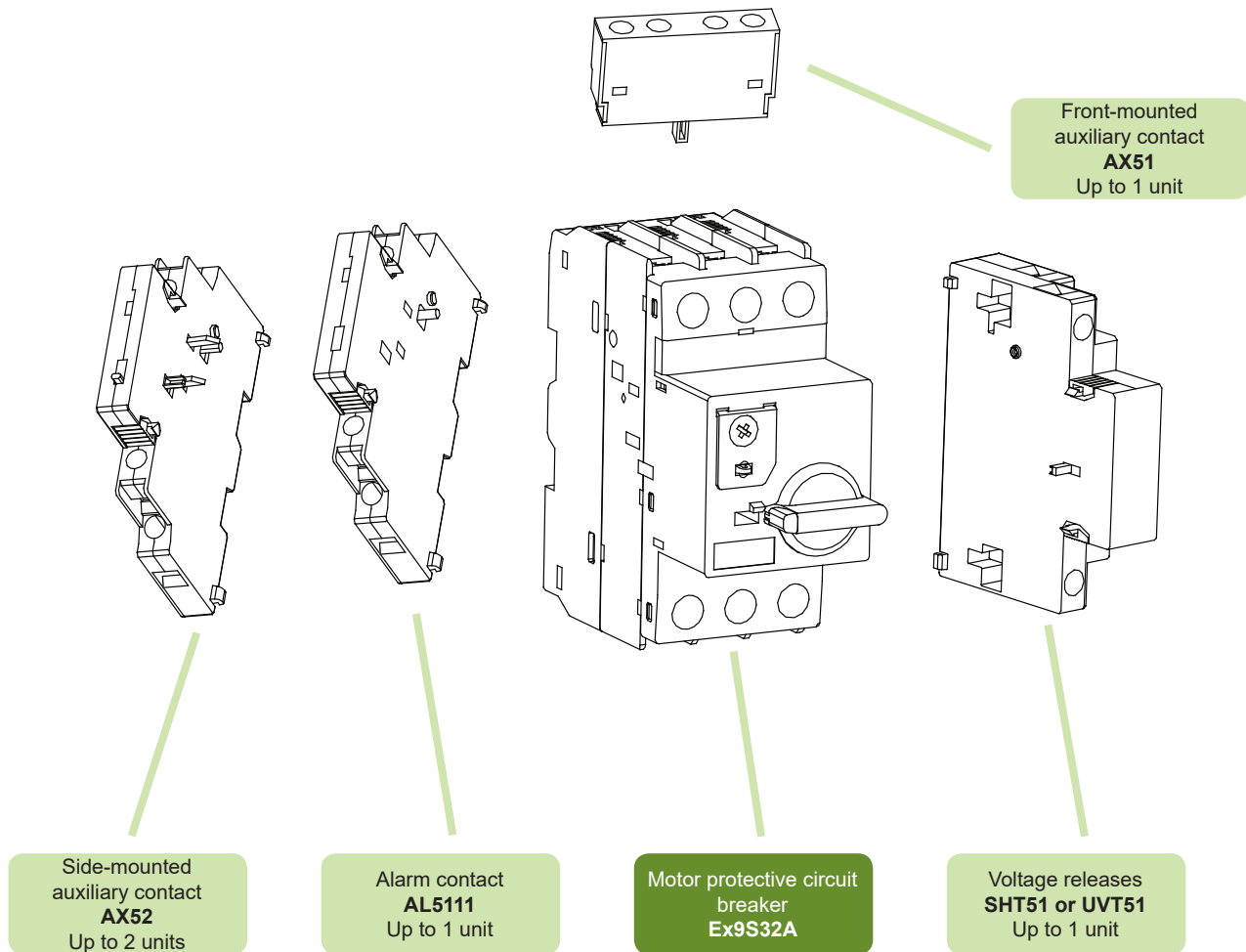

Auxiliary contacts AX51

Auxiliary contacts AX52

Alarm contact AL5111

Shunt trip release SHT51

Undervoltage release UVT51

Terminal adapters CC5

Adapter holder DRA51

Motor protective circuit breakers Ex9S32A

Motor protective circuit breakers, 3-pole

- Adjustable overload protection I_r
- Fixed instantaneous short-circuit current protection I_i (ca. $11 - 14 \times I_e$)
- Temperature compensation function to reduce the impact of ambient temperature
- Control rotary knob lock mechanism



Rated current I_e	Tripping current setting range I_r	Short-circuit current I_i	Article No.	Type	Packing
0.16 A	0.10 – 0.16 A	2.1 A	108096	Ex9S32A 0.16A	1/30
0.25 A	0.16 – 0.25 A	3.2 A	108097	Ex9S32A 0.25A	1/30
0.40 A	0.25 – 0.40 A	4.8 A	108098	Ex9S32A 0.4A	1/30
0.63 A	0.40 – 0.63 A	7.2 A	108099	Ex9S32A 0.63A	1/30
1.0 A	0.63 – 1.00 A	11 A	108100	Ex9S32A 1A	1/30
1.6 A	1.0 – 1.6 A	20 A	108101	Ex9S32A 1.6A	1/30
2.5 A	1.6 – 2.5 A	30 A	108102	Ex9S32A 2.5A	1/30
4.0 A	2.5 – 4.0 A	50 A	108103	Ex9S32A 4A	1/30
6.3 A	4.0 – 6.3 A	72.5 A	108104	Ex9S32A 6.3A	1/30
10 A	6.0 – 10 A	130 A	108105	Ex9S32A 10A	1/30
14 A	9.0 – 14 A	175 A	108106	Ex9S32A 14A	1/30
18 A	13 – 18 A	230 A	108107	Ex9S32A 18A	1/30
23 A	17 – 23 A	280 A	108108	Ex9S32A 23A	1/30
25 A	20 – 25 A	280 A	108109	Ex9S32A 25A	1/30
32 A	24 – 32 A	416 A	108110	Ex9S32A 32A	1/30

Technical Data Ex9S32A

Motor protective circuit breakers Ex9S32A

General parameters

For protection of various motor applications

Provide overload, short-circuit and phase-failure protection

Can replace the circuit breaker and thermal relay to reduce costs and space

Temperature compensation function to reduce the impact of ambient temperature

Accessories

Front-mounted auxiliary contacts	AX51 11, AX51 20	108143, 108144
Side-mounted auxiliary contacts	AX52 11, AX52 20, AX52 02	108145, 108146, 108147
Alarm contact	AL5111	108154
Undervoltage releases	UVT51I, UVT51J, UVT51K	108148, 108149, 108150
Shunt trip releases	SHT51F, SHT51G, SHT51H	108151, 108152, 108153
Max. number of installed accessories are 2 pcs of contact or signal units (2 pcs of AX52 or 1 pc of AX52 + 1 pc of AL5111) or 1 pc of front-mounted contact unit (AX51) and 1 pc of voltage release (SHT51, UVT51)		

Electrical parameters

Tested according to	IEC/EN 60947-4-1 IEC/EN 60947-2
Rated operating voltage U_e	400/690 V AC
Rated frequency f	50/60 Hz
Rated insulation voltage U_i	690 V
Rated impulse withstand voltage U_{imp}	6 kV
Rated current I_e	0.16 – 32 A
Fixed rated inst. short-circuit current I_i	see table below for exact values
Conventional free air thermal current I_{th}	$I_{th} = I_e$
Rated ultimate short-circuit breaking capacity I_{cu} (IEC/EN 60947-2)	
I_e 0.1 – 14 A at 400 V AC	100 kA
I_e 18 – 32 A at 400 V AC	50 kA
I_e 0.16 – 2.5 A at 690 V AC	100 kA
I_e 4 – 32 A at 690 V AC	6 kA
Rated service short-circuit breaking capacity I_{cs} (IEC/EN 60947-2)	
I_e 0.16 – 14 A at 400 V AC	100 kA
I_e 18 – 32 A at 400 V AC	30 kA
I_e 0.16 – 2.5 A at 690 V AC	100 kA
I_e 4 – 32 A at 690 V AC	4 kA
Required contactor type	
I_e 0.1 – 10 A	Ex9CS06/09 or Ex9C12 frame size
I_e 14 – 32 A	Ex9C18/25/32/38 frame size
Maximum operating frequency	30 operating cycles per hour
Electrical service life	100 000 operating cycles (at 400 V AC-3)

Technical Data Ex9S32A

Motor protective circuit breakers Ex9S32A

Mechanical parameters

Device width	45 mm
Device height	97 mm
Device depth	98 mm
Frame size	45 mm
Mounting	easy fastening onto 35 mm device rail (DIN)
Safety arcing distance	50 mm
Degree of protection	IP20
Mechanical service life	100 000 operating cycles
Terminals	lift
Terminal capacity	1 – 10 mm ²
Fastening torque of terminals	2.5 Nm
Ambient temperature	-5 – +40 °C
Altitude	≤ 2 000 m
Relative humidity	≤ 90 %
Resistance to climatic conditions	class 2, according to EN60068-2-3 and EN60068-2-30
Resistance to mechanical shock	30 gn (shock duration 11 ms)
Resistance to vibrations	5 gn (5 – 150 Hz)
Pollution degree	3
Installation class	III
Weight	0.33 kg

Dimensions

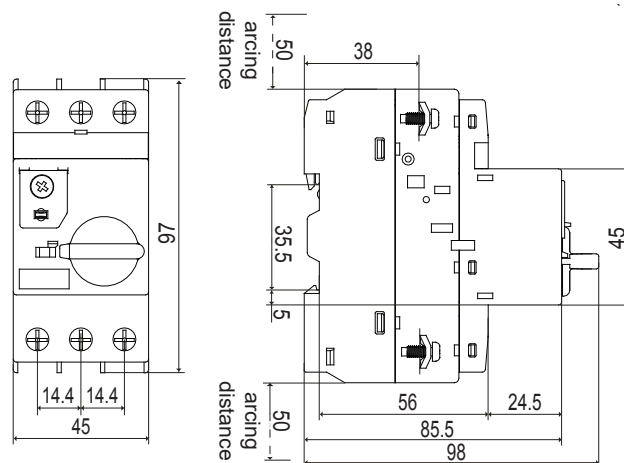

Mounting positions

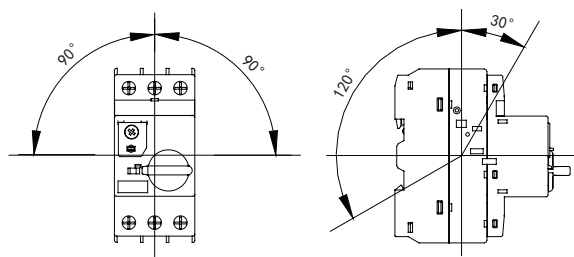

Technical Data Ex9S32A

Motor protective circuit breakers Ex9S32A

Rated instantaneous short-circuit current I_i

I_o [A]	0.16 A	0.25 A	0.4 A	0.63 A	1 A	1.6 A	2.5 A	4 A	6.3 A	10 A	14 A	18 A	23 A	25 A	32 A
I_i [A]	2.1	3.2	4.8	7.2	11	20	30	50	72.5	130	175	230	280	280	416

Rated power of three-phase motor

I_o [A]	AC-3, 50/60 Hz [kW]				
	230 V	400 V	440 V	500 V	690 V
0.16 A	-	-	-	0.06	0.06
0.25 A	-	0.06	0.06	0.09	0.12
0.4 A	0.06	0.09	0.09	0.12	0.18
0.63 A	0.09	0.18	0.18	0.18	0.25
1 A	0.18	0.25	0.25	0.37	0.55
1.6 A	0.25	0.55	0.55	0.75	1.1
2.5 A	0.37	0.75	0.75	1.1	1.5
4 A	0.75	1.5	1.5	2.2	3.0
6.3 A	1.5	2.2	2.2	3.0	4.0
10 A	2.2	4.0	4.0	5.5	7.5
14 A	3.0	5.5	5.5	7.5	11
18 A	4.0	7.5	7.5	11	15
23 A	5.5	11	11	15	18.5
25 A	5.5	11	11	15	22
32 A	7.5	15	15	18.5	30

Connection diagrams

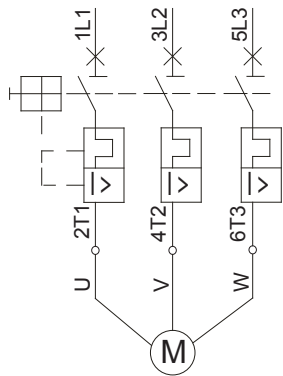

3-phase motor protection

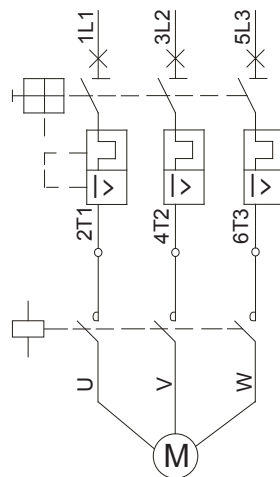

3-phase motor protection with contactor

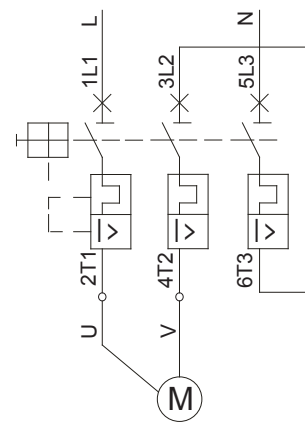

1-phase or DC motor protection

Technical Data Ex9S32A

Motor protective circuit breakers Ex9S32A

Tripping characteristics

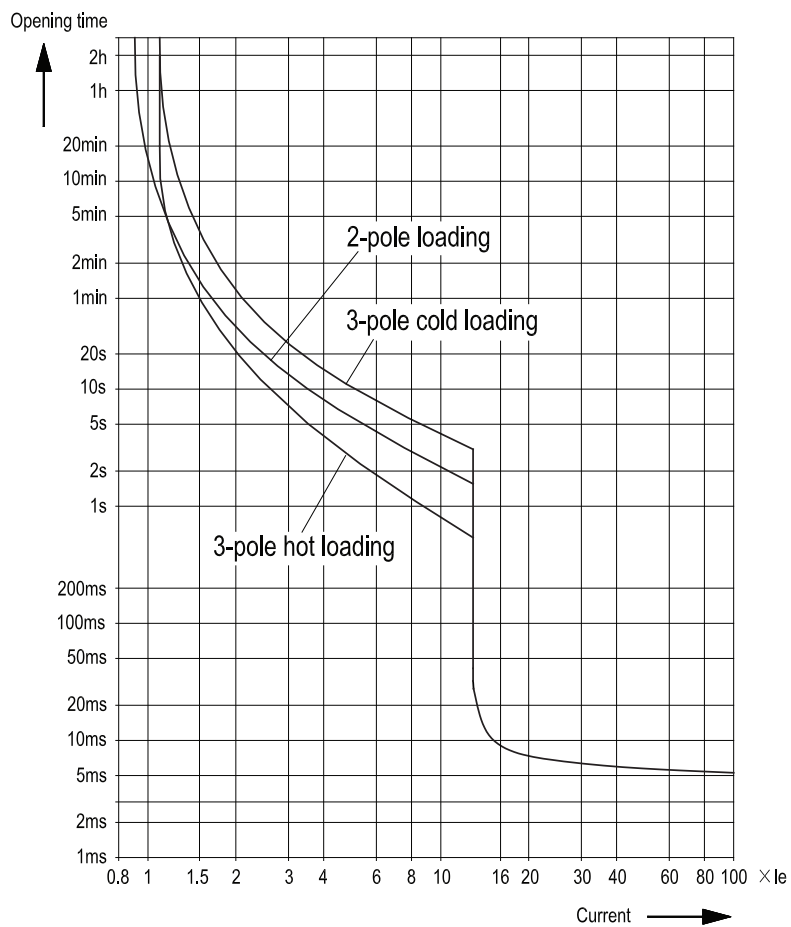

Accessories for Ex9S32A



- Accessories for motor protective circuit breakers Ex9S32A
- Front-mounted auxiliary contacts AX51
- Side-mounted auxiliary contacts AX52
- Side-mounted alarm contact AL5111
- Shunt trip release SHT51
- Undervoltage release UVT51
- Terminal adapters CC5
- Adapter holder DRA51

Ex9S32A motor protective circuit breakers can be equipped with various types of additional accessories. All the accessories are designed in the way to be possible to combine different types with one device. There can be used up to three auxiliary or alarm contact units plus one voltage release.

Auxiliary contact units are available with three possible contact combinations. Auxiliary and alarm contact units to be mounted from the left to the device. Release units are mounted from the right side. Installation of an auxiliary or alarm contact units does not affect the possibility of installing voltage release.

Type Key

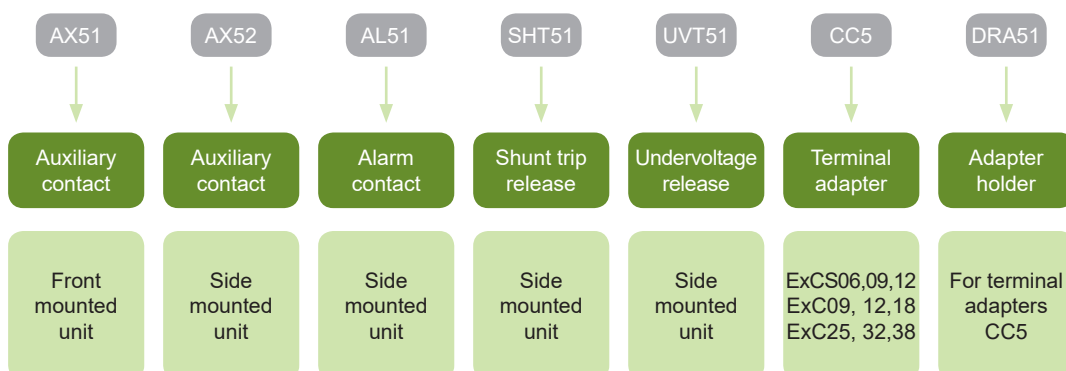

Accessories for Ex9S32A

Auxiliary contacts for Ex9S32A, front-mounted



Contacts	Suitable for	Article No.	Type	Packing
1 NO + 1 NC	Ex9S32A	108143	AX51 11	10/720
2 NO	Ex9S32A	108144	AX51 20	10/720

Auxiliary contacts for Ex9S32A, side-mounted



Contacts	Suitable for	Article No.	Type	Packing
1 NO + 1 NC	Ex9S32A	108145	AX52 11	2/192
2 NO	Ex9S32A	108146	AX52 20	2/192
2 NC	Ex9S32A	108147	AX52 02	2/192

Alarm contact for Ex9S32A, side-mounted



Contacts	Suitable for	Article No.	Type	Packing
1 NO + 1 NC	Ex9S32A	108154	AL5111	1/96

Shunt trip releases for Ex9S32A, side-mounted



AC oper. voltage	Suitable for	Article No.	Type	Packing
110 – 115 V AC	Ex9S32A	108151	SHT51F	1/96
220 – 240 V AC	Ex9S32A	108152	SHT51G	1/96
380 – 400 V AC	Ex9S32A	108153	SHT51H	1/96

Accessories for Ex9S32A

Undervoltage releases for Ex9S32A, side-mounted



AC oper. voltage	Suitable for	Article No.	Type	Packing
110 – 115 V AC	Ex9S32A	108148	UVT51I	1/96
220 – 240 V AC	Ex9S32A	108149	UVT51J	1/96
380 – 400 V AC	Ex9S32A	108150	UVT51K	1/96

Terminal adapters for Ex9S32A



For contactors size	Suitable for	Article No.	Type	Packing
Ex9CS06, 09, 12	Ex9S32A	108155	CC51	6/240
Ex9C09, 12, 18	Ex9S32A	109077	CC52	3/120
Ex9C25, 32, 38	Ex9S32A	109078	CC53	3/60

Adapter holder for Ex9S32A



For terminal adapters	Suitable for	Article No.	Type	Packing
CC51, CC52, CC53	Ex9S32A	109079	DRA51	16/96

Technical Data Ex9S32A accessories

Accessories for motor protective circuit breakers Ex9S32A line

Front-mounted auxiliary contact unit AX51

General parameters

For subsequent mounting

Front-mounted version

1 unit can be used with a motor protective circuit breaker

Electrical parameters

	AX51 11	AX51 20
Contacts	1 NO + 1 NC	2 NO
Tested according to	IEC/EN 60947-5-1	
Rated operating voltage U_e	240 V AC, 60 V DC	
Rated frequency	50/60 Hz	
Rated thermal current I_{th}	2.5 A	
Rated op. current I_e , ut. cat. AC-15	0.5 A at 240 V	
Rated op. current I_e , ut. cat. DC-13	0.15 A at 60 V	
Rated impulse withstand voltage U_{imp}	2.5 kV	
Rated insulation voltage U_i	250 V	
Max. back-up fuse	4A gG/gL	

Mechanical parameters

	AX51 11	AX51 20
Device width	45 mm	
Device height	14 mm	
Device depth	32.5 mm	
Mounting	front	
Degree of protection	IP20	
Terminals	lift	
Terminal capacity	1 – 2.5 mm ²	
Fastening torque of terminals	0.8 Nm	

Wiring diagram

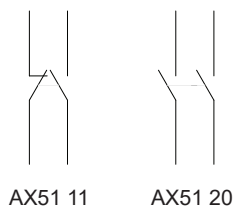

Technical Data Ex9S32A accessories

Accessories for motor protective circuit breakers Ex9S32A line

Side-mounted auxiliary contact unit AX52

General parameters

For subsequent mounting

Side-mounted version, mounting from the left

Up to 2 units can be used with a motor protective circuit breaker

Electrical parameters

	AX52 11	AX52 20	AX52 02
Contacts	1 NO + 1 NC	2 NO	2 NC
Tested according to	IEC/EN 60947-5-1		
Rated operating voltage U_e	240 V AC, 415 V AC, 250 V DC, 400 V DC		
Rated frequency f	50/60 Hz		
Rated thermal current I_{th}	5 A		
Rated op. current I_e , ut. cat. AC-15	1.5 A at 240 V, 1 A at 415 V		
Rated op. current I_e , ut. cat. DC-13	0.2 A at 250 V, 0.1 A at 400 V		
Rated impulse withstand voltage U_{imp}	4 kV		
Rated insulation voltage U_i	690 V		
Max. back-up fuse	6A gG/gL		

Mechanical parameters

	AX52 11	AX52 20	AX52 02
Device width		9.5 mm	
Device height		98 mm	
Device depth		85.5 mm	
Mounting		left side	
Degree of protection		IP20	
Terminals		lift	
Terminal capacity		1 – 2.5 mm ²	
Fastening torque of terminals		0.8 Nm	

Wiring diagram

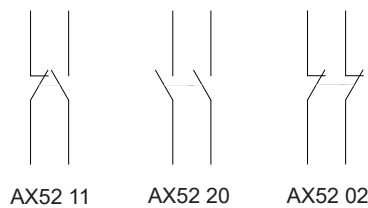

Technical Data Ex9S32A accessories

Accessories for motor protective circuit breakers Ex9S32A line

Side-mounted auxiliary unit with status signalization AL5111

General parameters

For subsequent mounting
Side-mounted version
1 unit can be used with a motor protective circuit breaker

Electrical parameters

	AL5111
Contacts	1 NO + 1 NC
Tested according to	IEC/EN 60947-5-1
Rated operating voltage U_e	240 V AC, 415 V AC, 250 V DC, 400 V DC
Rated frequency	50/60 Hz
Rated thermal current I_{th}	5 A
Rated op. current I_e , ut. cat. AC-15	1.5 A at 240 V, 1 A at 415 V
Rated op. current I_e , ut. cat. DC-13	0.2 A at 250 V, 0.1 A at 400 V
Rated impulse withstand voltage U_{imp}	4 kV
Rated insulation voltage U_i	690 V
Max. back-up fuse	6A gG/gL

Mechanical parameters

	AL5111
Device width	9.5 mm
Device height	98 mm
Device depth	85.5 mm
Mounting	front
Degree of protection	IP20
Terminals	lift
Terminal capacity	1 – 2.5 mm ²
Fastening torque of terminals	0.8 Nm

Wiring diagram

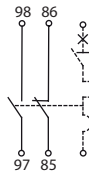

Technical Data Ex9S32A accessories

Accessories for motor protective circuit breakers Ex9S32A line

Shunt trip releases SHT51

General parameters

For subsequent mounting

Side-mounted version, mounting from the right

1 unit can be used with a motor protective circuit breaker or UVT51 unit

Electrical parameters

	SHT51F	SHT51G	SHT51H
Tested according to	IEC/EN 60947-2		
Rated operating voltage U_e	110 – 115 V AC at 50 Hz 127 V AC at 60 Hz	220 – 240 V AC at 50 Hz	380 – 400 V AC at 50 Hz 440 V AC at 60 Hz
Oper. voltage tripping tolerance	70 – 110 % U_e		
Rated frequency f	50/60 Hz	50 Hz	50/60 Hz
Rated impulse withstand voltage U_{imp}	6 kV		
Rated insulation voltage U_i	690 V		

Mechanical parameters

	SHT51F	SHT51G	SHT51H
Device width	18.5 mm		
Device height	98 mm		
Device depth	85.5 mm		
Mounting	right side		
Degree of protection	IP20		
Terminals	lift		
Terminal capacity	1 – 2.5 mm ²		
Fastening torque of terminals	1.7 Nm		

Wiring diagram

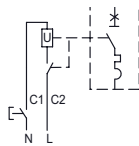

Technical Data Ex9S32A accessories

Accessories for motor protective circuit breakers Ex9S32A line

Undervoltage releases UVT51

General parameters

For subsequent mounting
Side-mounted version, mounting from the right
1 unit can be used with a motor protective circuit breaker or SHT51 unit

Electrical parameters

	UVT51I	UVT51J	UVT51K
Tested according to	IEC/EN 60947-2		
Rated operating voltage U_e	110 – 115 V AC at 50 Hz 127 V AC at 60 Hz	220 – 240 V AC at 50 Hz	380 – 400 V AC at 50 Hz 440 V AC at 60 Hz
Rated frequency f	50/60 Hz	50 Hz	50/60 Hz
Rated impulse withstand voltage U_{imp}	6 kV		
Rated insulation voltage U_i	690 V		
Tripping time	200 ms		
Making threshold	85 % U_e		
Tripping threshold	70 – 35 % U_e		

Mechanical parameters

	UVT51I	UVT51J	UVT51K
Device width	18.5 mm		
Device height	98 mm		
Device depth	85.5 mm		
Mounting	right side		
Degree of protection	IP20		
Terminals	lift		
Terminal capacity	1 – 2.5 mm ²		
Fastening torque of terminals	1.7 Nm		

Wiring diagram

